

Features

Defogger: have your mirror fog free with a touch of a button. Dedicated defogger button is located along the frame on the inside of the cabinet.

3X LED Lighted Magnifying Mirror: A built-in, removable, LED-lighted magnifying mirror on the inside of the door, is vertically adjustable flip-out flat to accommodate users of varying heights.

Dimmer: Dim the light of your choice by holding down the on button.
Digital Clock: modern and convenient feature.

Electrical Outlets: Dual electrical outlets with USB are located inside the cabinet.

Light Control: Cycle through the color temperature light with a tap of a dedicated button, 3 Color temperature lights. Warm, Cool, and Neutral.

Inside Lighting: the light sensor switches the interior light automatically.

Digital Clock: modern and convenient feature.

Kelvin	3000	6500	4500 mixed color
CRI	80+	80+	80+
Lumens*†	810	810	1620
R9 Value*	50+	50+	50+
Watts (AC)	60	60	60
Lumens per Watt	90	90	90

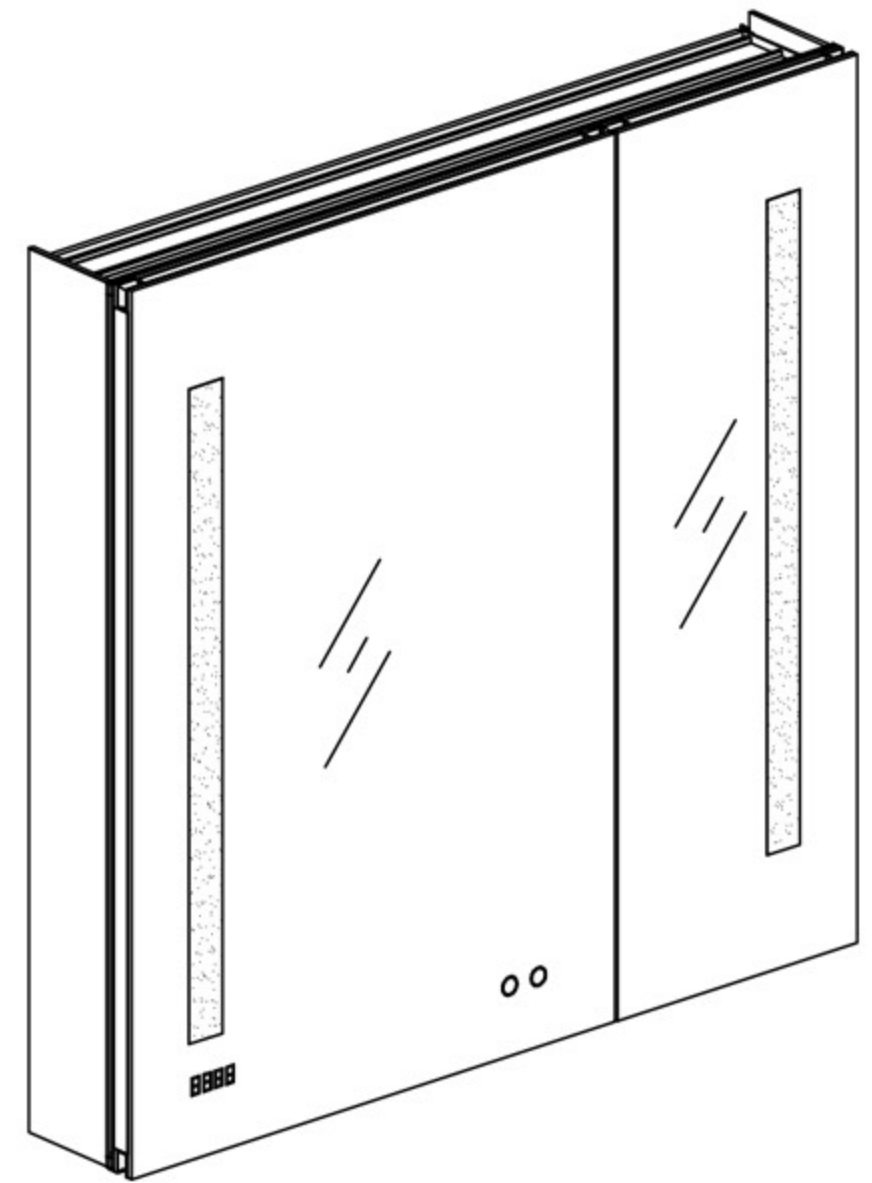

Construction

BLUM Soft Close Hinges: Soft Close hinges allow for a smooth and secure 155-degree opening.

Glass Shelves: 8mm clear adjustable glass shelves are included for you to arrange them according to your needs.

Mirror: Quality polished edge 5mm silver mirrored glass is used for the best front-surface reflexivity in the visible spectrum.

Interior: Double Sided Mirrored Doors and Back Wall.

Installation: Recessed or Surface Mount.

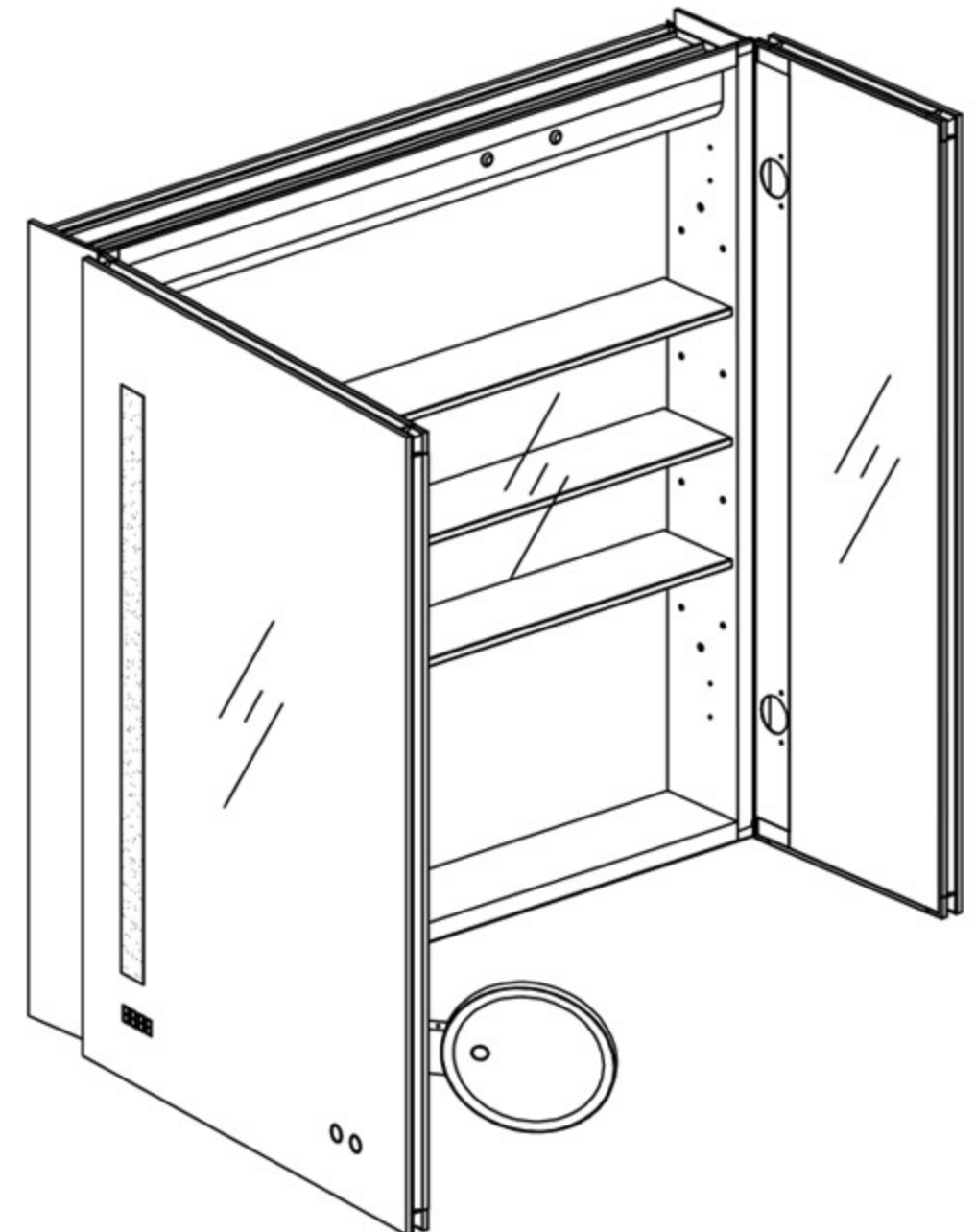

Codes/Standards Applicable

Electric Option Models are ETL certified to:

UL 962

CSA Standard C22.2 No.68

Dimensions

Height: 30" (762 mm)

Width: 30" (762 mm)

Depth When surface mounted: 5" (127 mm)

Depth When recessed: 1" (25mm)

30" W x 30" H x 5" D

Installation Options

- Recessed Mount - Rough Opening - 29-1/2" H x 29-1/2" W x 4" D (749mm H x 749mm W x 102mm D)
- Surface Mount - Surface Mount Kit is included

Electrical System

- 60 Watts LED Driver
- INPUT : 120VAC 60HZ 1.2A
- OUTPUT : 12VAC 5.0A
- Field wire location as shown in drawing
- 1/2" conduit (Ø 7/8" actual) electrical knockout location shown below
- Included field wire cable clamp
- Circuit Diagram

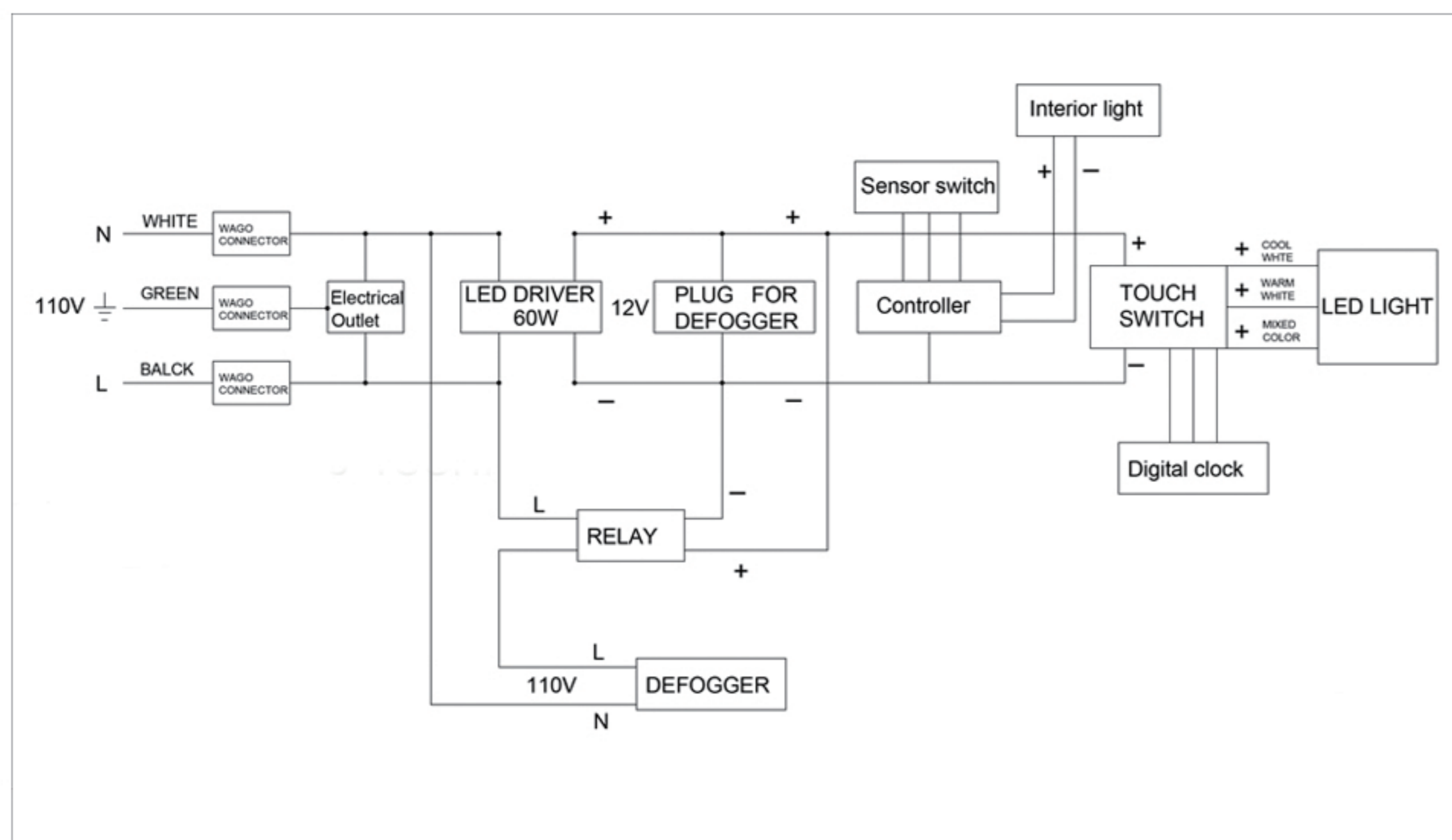

Circuit Diagram

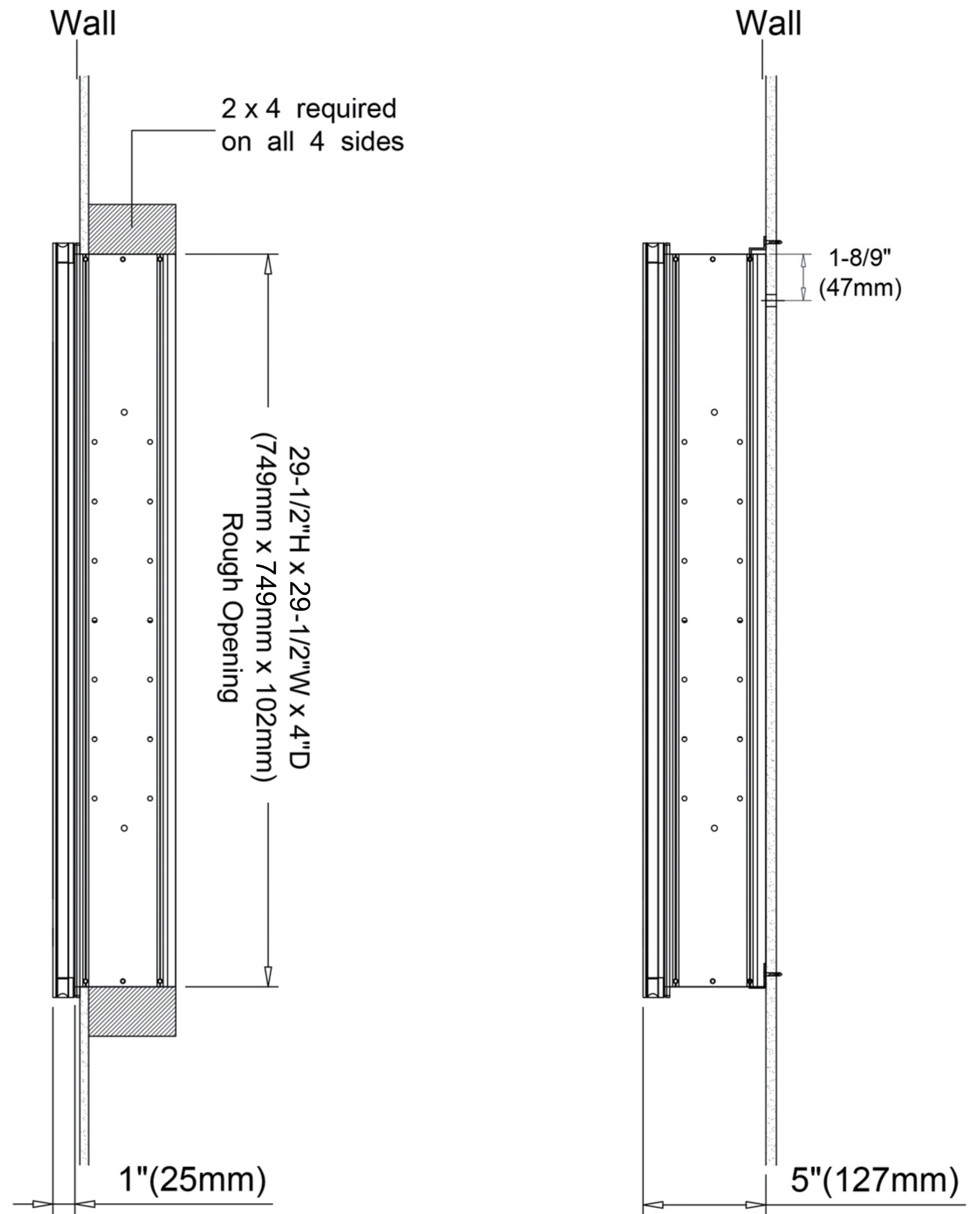

Recessed Mount

Surface Mount

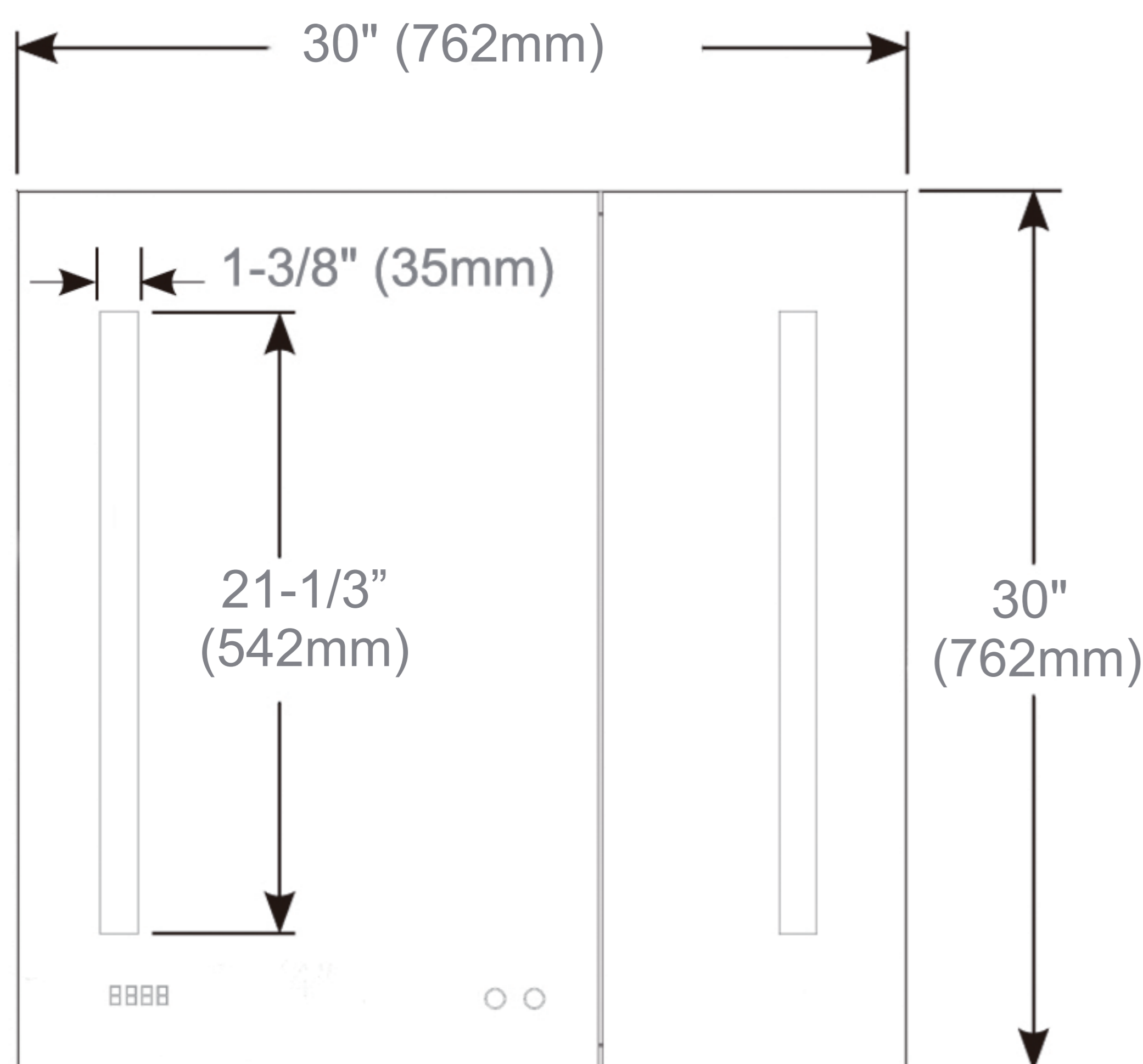

Cabinet Dimensions

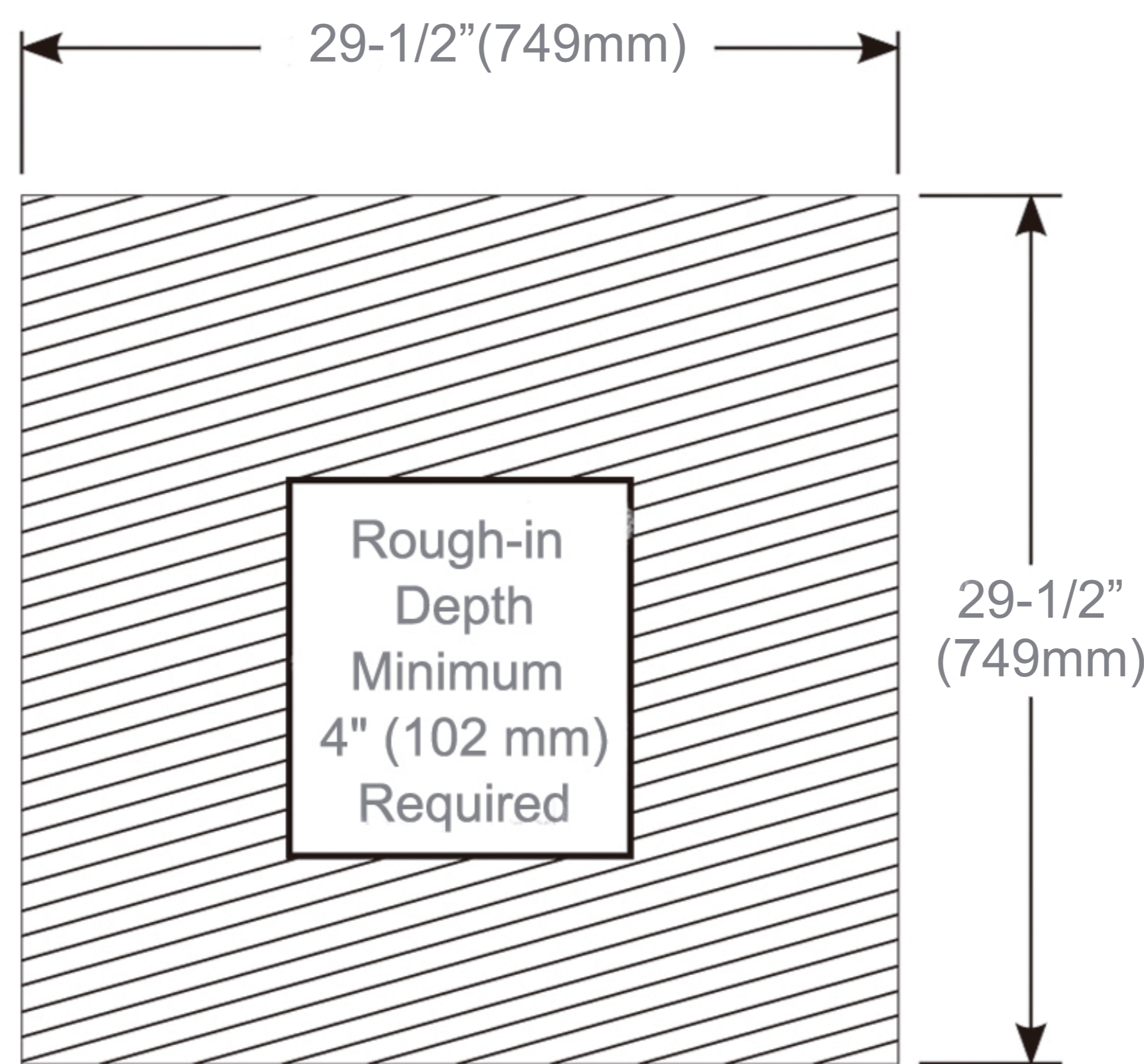

Rough-in Dimensions

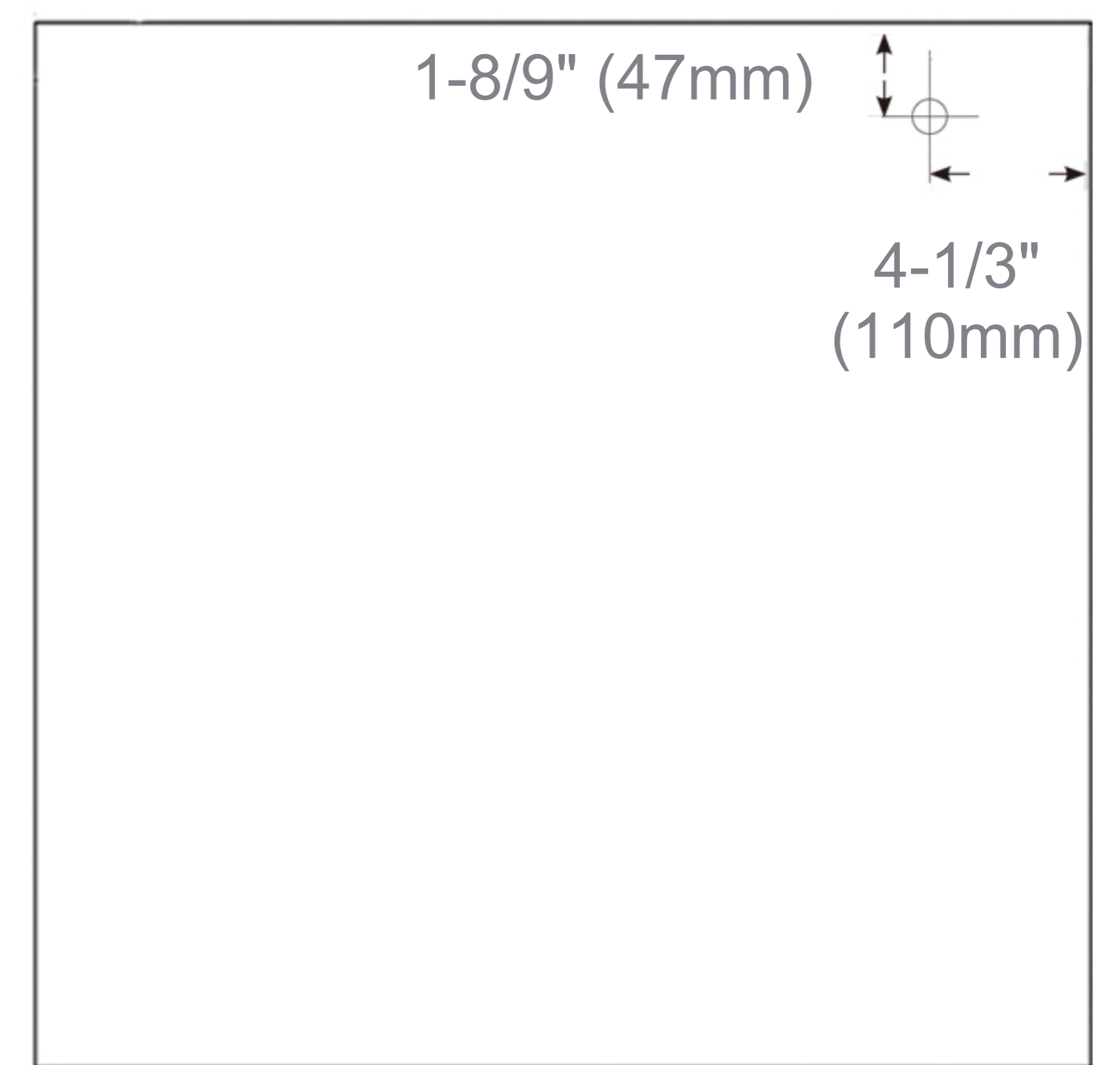

Back of Cabinet - Wire Access Location