

AQUADOM  

---

INSTALLATION GUIDE







# AQUADOM Royale Installation Guide

## ASSEMBLY TOOLS

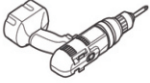

1/8" Drill Bit

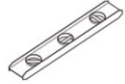

## PARTS

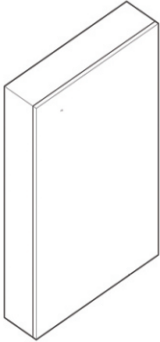

Single Door

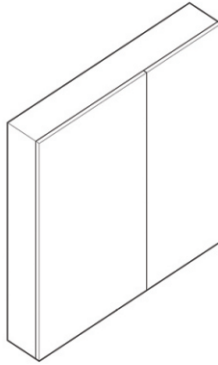

Double Door

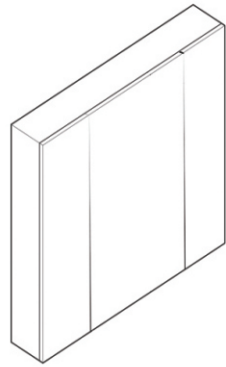

Triple Door

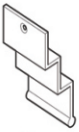

Top Mounting Bracket



Shelf Clip



Bottom Mounting Bracket



Bumper

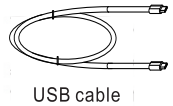

USB cable



Glass Shelf



Glass Side Panel



Hole Plug



Screw



Makeup Mirror



Wall Plug Anchor

## HERRAMIENTAS PARA ARMADO

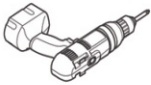

1/8" Drill Bit

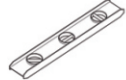

## PIEZAS

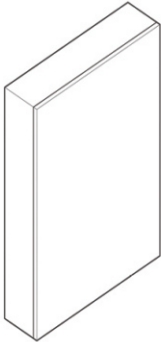

De una puerta

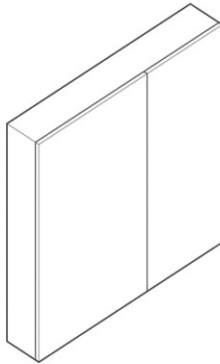

De Puerta Doble

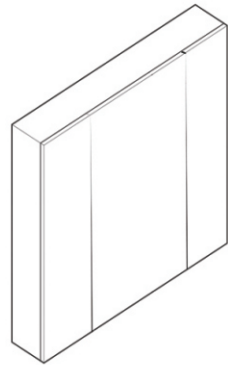

De Puerta Triple



Soporte de Montaje Superior



Soporte de Repisa



Soporte de Montaje Inferior



Bómper

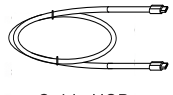

Cable USB



Vidrio de Repisa



Vidrio de Panel Lateral



Tapón de Agujero



Pijas



Espejo de maquillaje



Perno de anclaje

## OUTILS DE MONTAGE

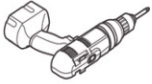

1/8" Drill Bit

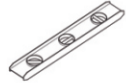

## PIÈCES

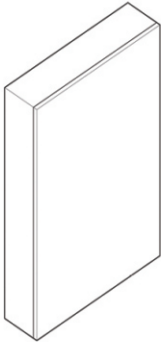

À Porte Simple

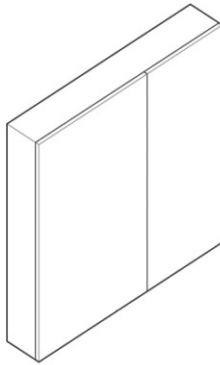

À Porte Double

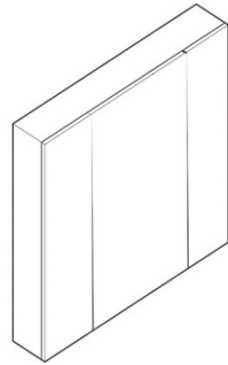

À Porte Triple

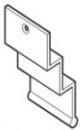

Support  
Supérieur  
de Montage



Support  
d'étagère

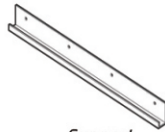

Support  
Inférieur  
de Montage



Pare-choc

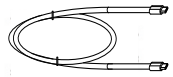

Câble USB



Tablette en Verre



Panneau de Côté  
en Verre



Capuchon  
de trou



Vis



Miroir de maquillage



Boulon d'ancrage



# AQUADOM Royale Installation Guide

## DIMENSIONS

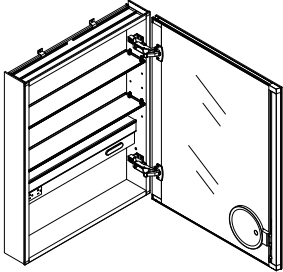

**A** - Cabinet's width

**B** - Cabinet's Height

**C** - Cabinet's DePth



**NOTE:** Determine overall medicine cabinet dimensions. if recessing medicine cabinet, determine rough-in dimensions.

ROYALE

| SIZE inches | ROUGH IN DIMENSIONS inches |
|-------------|----------------------------|
| 15 x 70     | 14.5 x 69.5                |
| 24 x 30     | 23.5 x 29.5                |
| 24 x 36     | 23.5 x 35.5                |
| 24 x 40     | 23.5 x 39.5                |
| 30 x 30     | 29.5 x 29.5                |
| 30 x 36     | 29.5 x 35.5                |
| 36 x 30     | 35.5 x 29.5                |
| 36 x 36     | 35.5 x 35.5                |
| 48 x 30     | 47.5 x 29.5                |
| 48 x 36     | 47.5 x 35.5                |
| 40 x 30     | 39.5 x 29.5                |
| 40 x 36     | 39.5 x 35.5                |
| 60 x 30     | 59.5 x 29.5                |
| 60 x 36     | 59.5 x 35.5                |
| 72 x 36     | 71.5 x 35.5                |

## DIMENSIONES

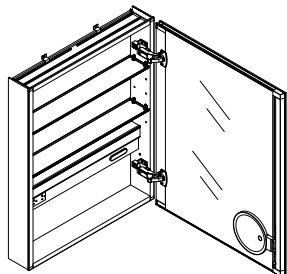

**A** - Ancho

**B** - Alto

**C** - Profundidad



**NOTA:** Básese en las dimensiones totales del gabinete de medicamentos. Si se trata de un gabinete empotrado, básese en las dimensiones de abertura.

ROYALE

| MEDIDAS en pulg. | DIMENSIONES DE ABERTURA en pulg. |
|------------------|----------------------------------|
| 15 x 70          | 14.5 x 69.5                      |
| 24 x 30          | 23.5 x 29.5                      |
| 24 x 36          | 23.5 x 35.5                      |
| 24 x 40          | 23.5 x 39.5                      |
| 30 x 30          | 29.5 x 29.5                      |
| 30 x 36          | 29.5 x 35.5                      |
| 36 x 30          | 35.5 x 29.5                      |
| 36 x 36          | 35.5 x 35.5                      |
| 48 x 30          | 47.5 x 29.5                      |
| 48 x 36          | 47.5 x 35.5                      |
| 40 x 30          | 39.5 x 29.5                      |
| 40 x 36          | 39.5 x 35.5                      |
| 60 x 30          | 59.5 x 29.5                      |
| 60 x 36          | 59.5 x 35.5                      |
| 72 x 36          | 71.5 x 35.5                      |

## DIMENSIONS

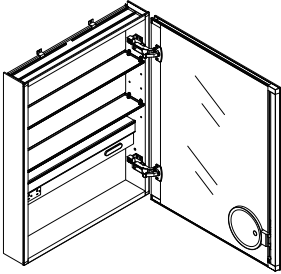

**A** - Largeur

**B** - Hauteur

**C** - Profondeur



**REMARQUE:** Prévoyez des dimensions totales de l'armoire. Dans le cas d'encastrement de l'armoire, prévoyez des dimensions d'ouverture.

ROYALE

| DIMENSIONS pouce | DIMENSIONS D'OUVERTURE pouce |
|------------------|------------------------------|
| 15 x 70          | 14.5 x 69.5                  |
| 24 x 30          | 23.5 x 29.5                  |
| 24 x 36          | 23.5 x 35.5                  |
| 24 x 40          | 23.5 x 39.5                  |
| 30 x 30          | 29.5 x 29.5                  |
| 30 x 36          | 29.5 x 35.5                  |
| 36 x 30          | 35.5 x 29.5                  |
| 36 x 36          | 35.5 x 35.5                  |
| 48 x 30          | 47.5 x 29.5                  |
| 48 x 36          | 47.5 x 35.5                  |
| 40 x 30          | 39.5 x 29.5                  |
| 40 x 36          | 39.5 x 35.5                  |
| 60 x 30          | 59.5 x 29.5                  |
| 60 x 36          | 59.5 x 35.5                  |
| 72 x 36          | 71.5 x 35.5                  |



## WIRING

\* AQUADOM Medicine Cabinet as seen from the back\*

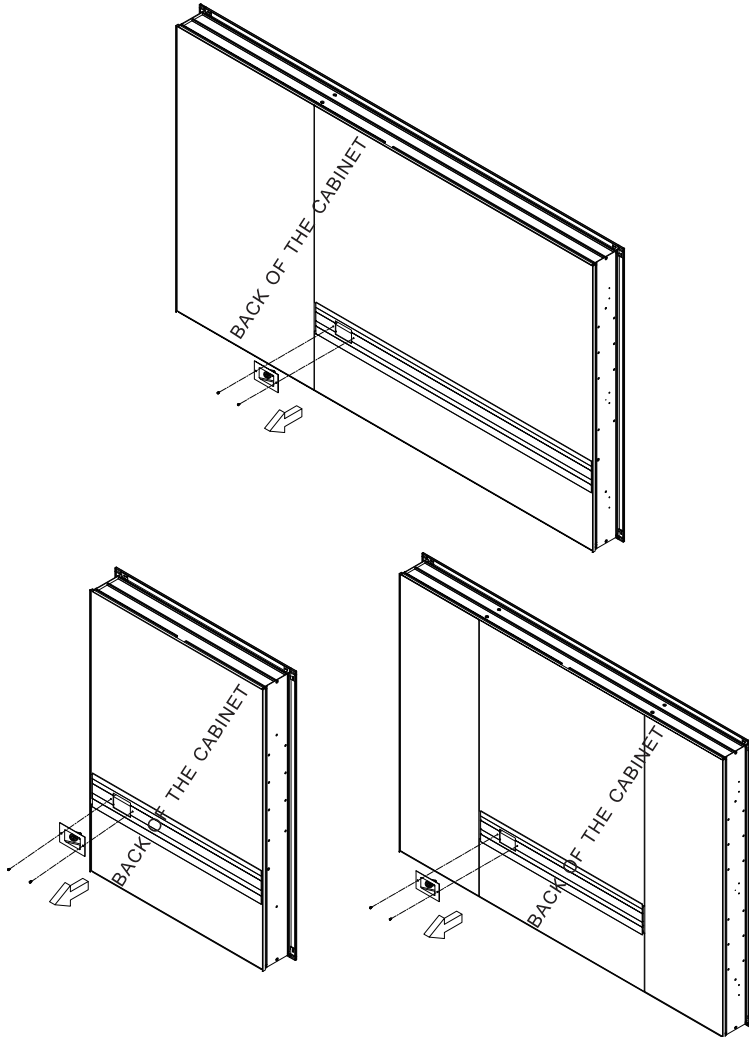

\* The wire bracket is located at the top right corner of the cabinet if viewed from the front\*

## CABLEADO

\*Gabinete para Medicamentos AQUADOM visto desde la parte trasera\*

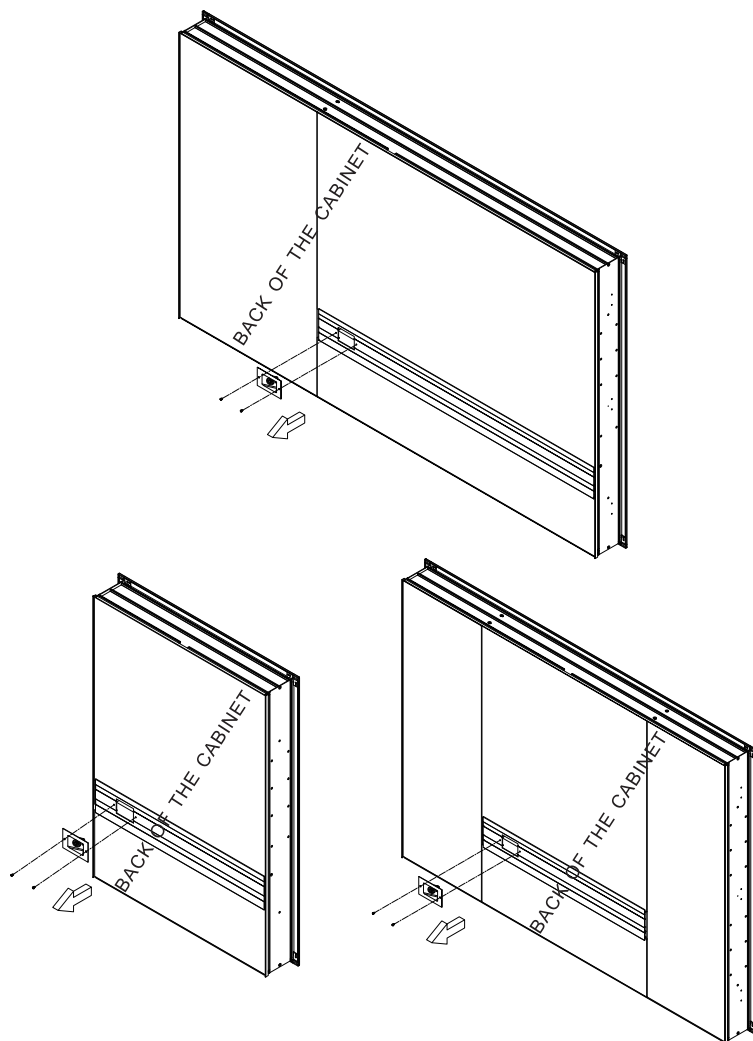

\* El soporte del cable está ubicado en la esquina superior derecha del gabinete viéndolo desde el frente \*

## CABLAGE

\* L'armoire à pharmacie AQUADOM vue de l'arrière\*

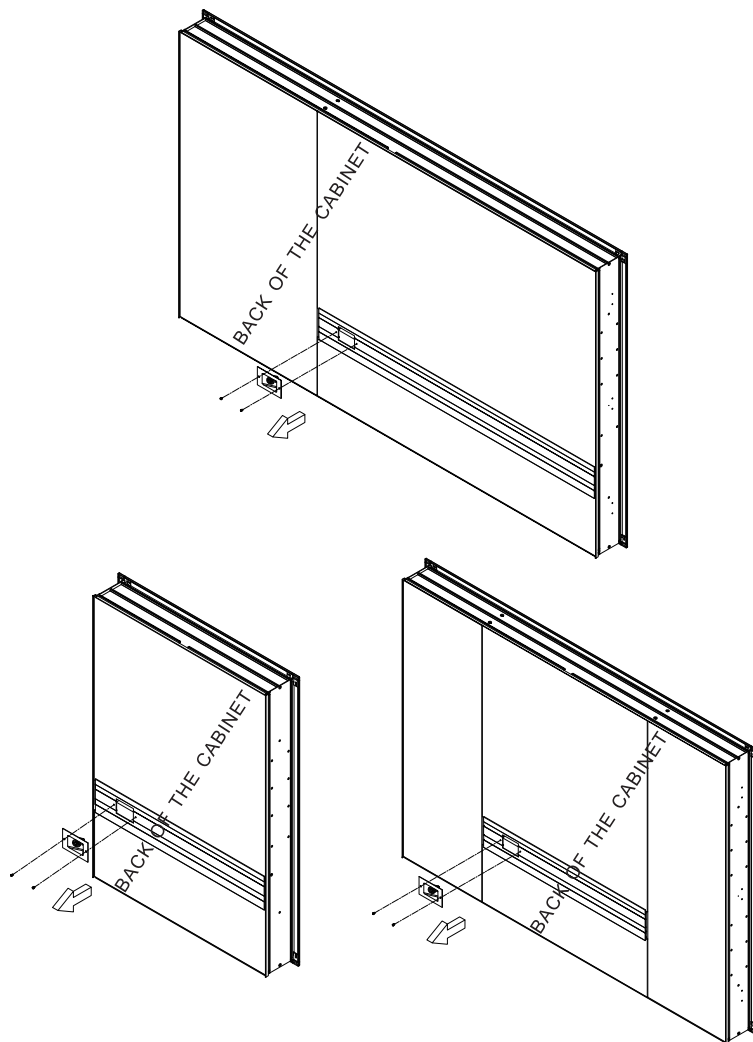

\*Le support de fil est situé dans le coin supérieur droit de l'armoire vu de l'avant\*

## WIRING

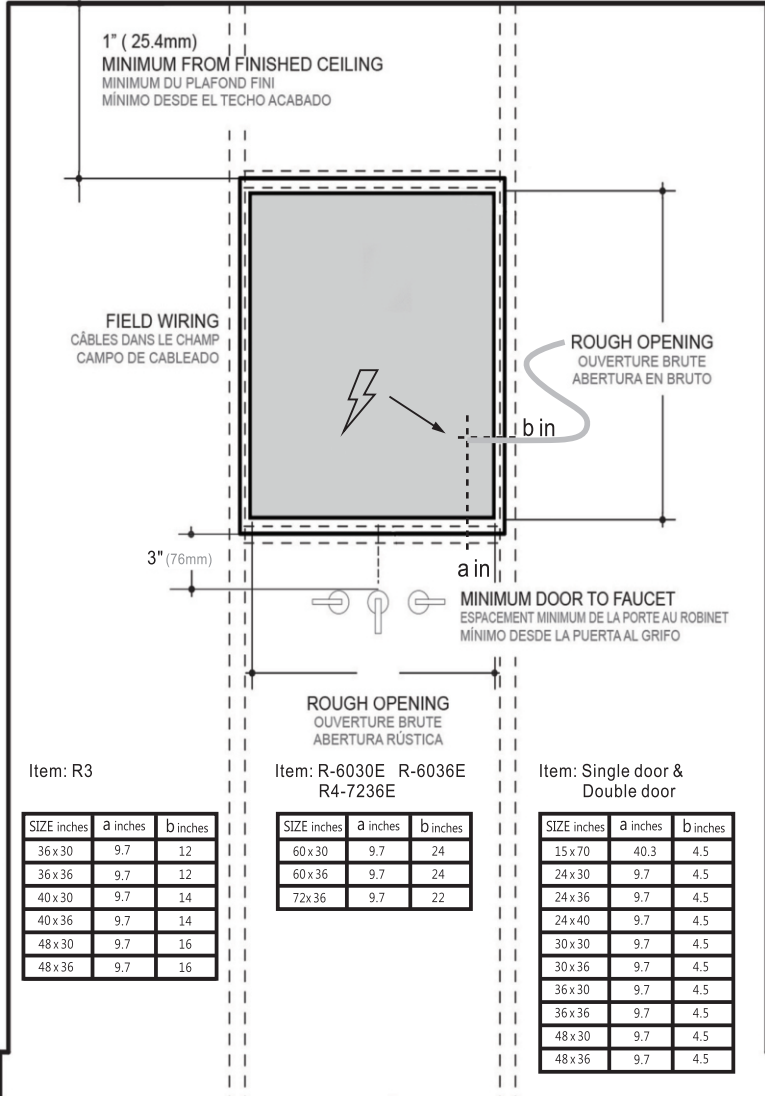

## CABLEADO

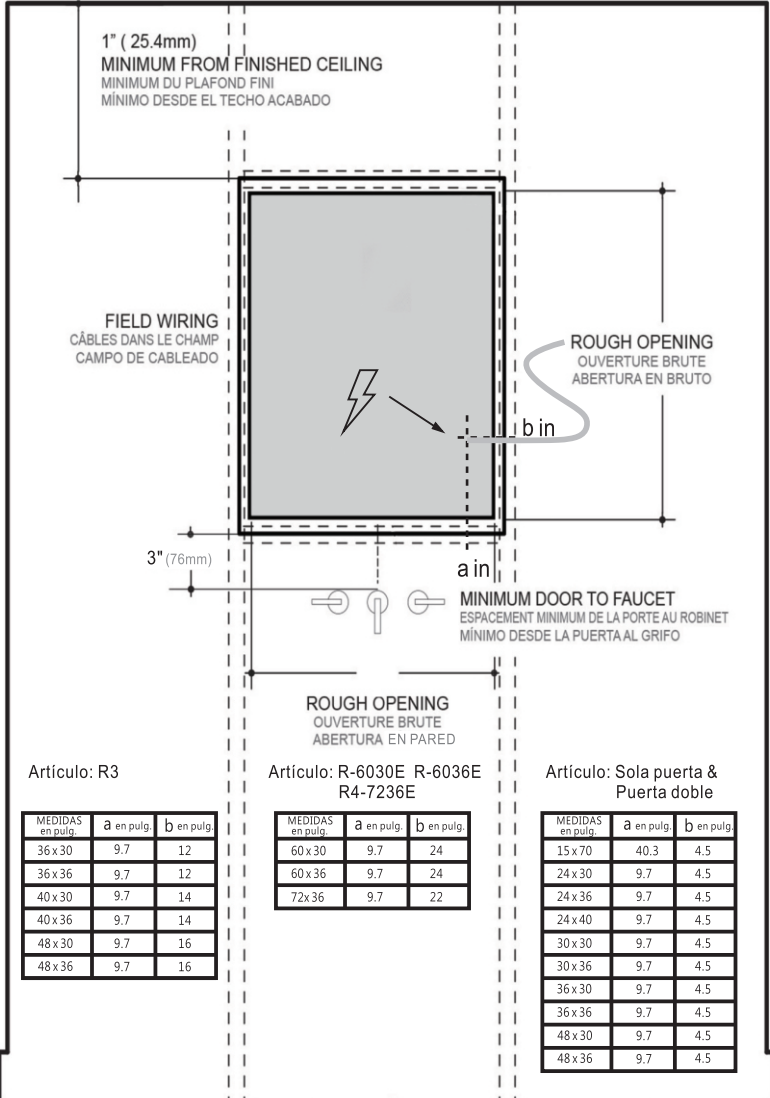

## CABLAGE

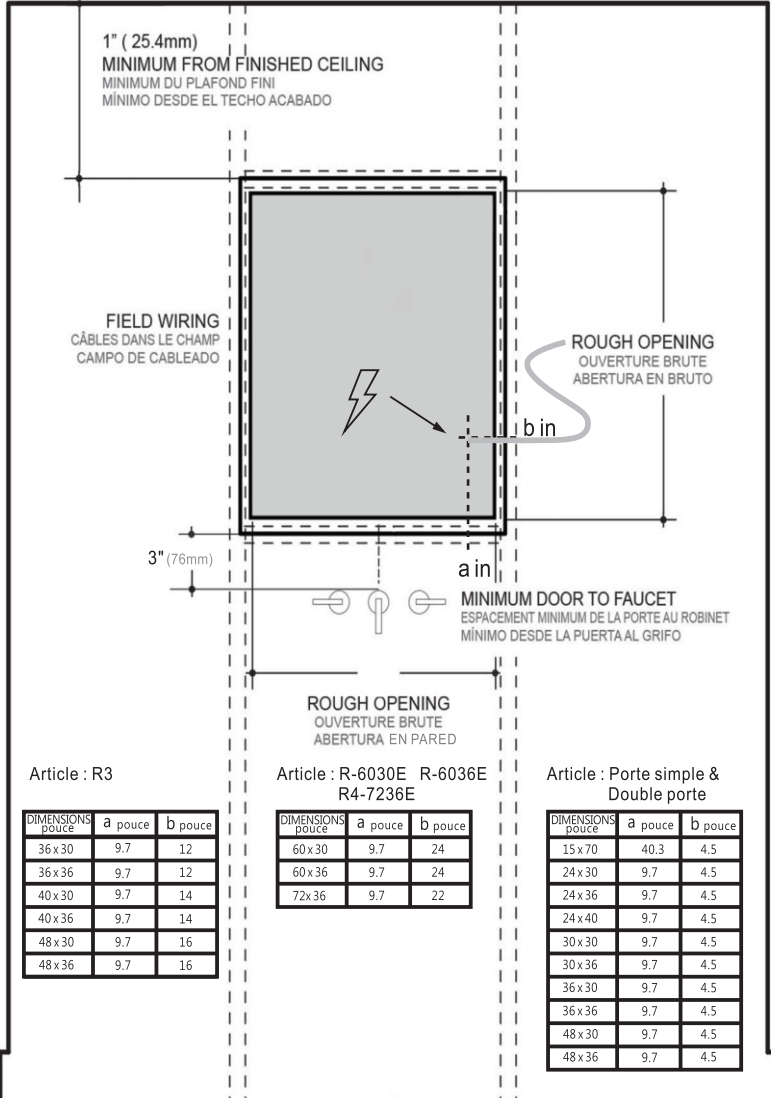

# INSTALLATION

## 1 Interior of the Medicine Cabinet

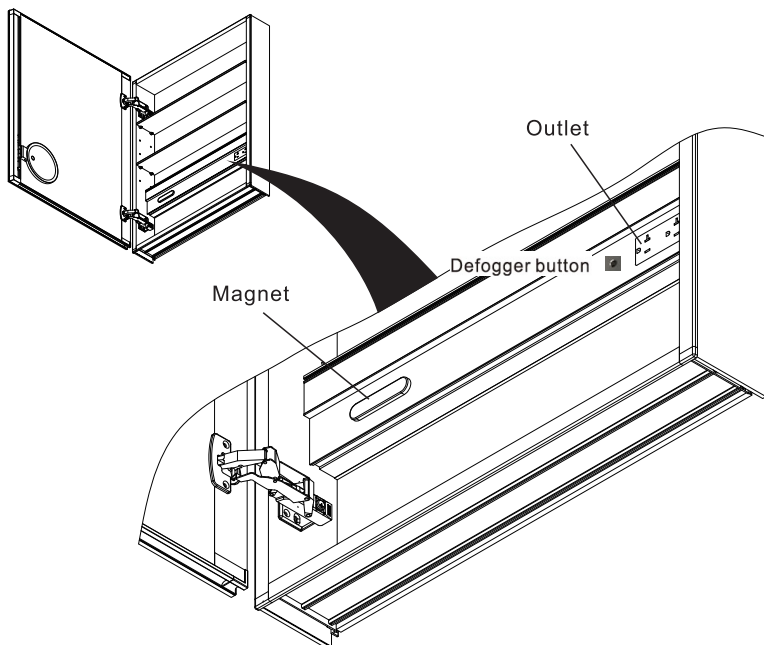

## 2 Remove mirrored side panels from the medicine cabinet using a screwdriver .

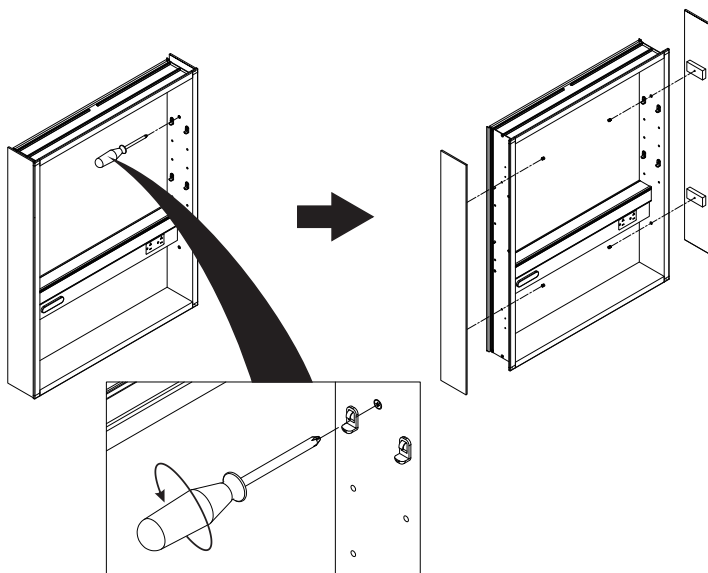

# INSTALACION

## 1 Interior del gabinete de medicina

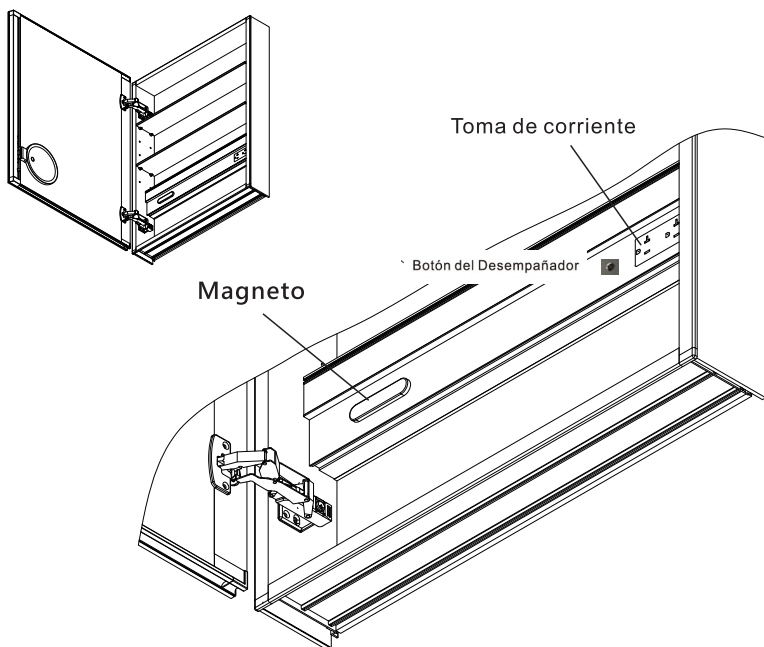

## 2 Retire los espejos laterales al gabinete utilizando un desarmador .

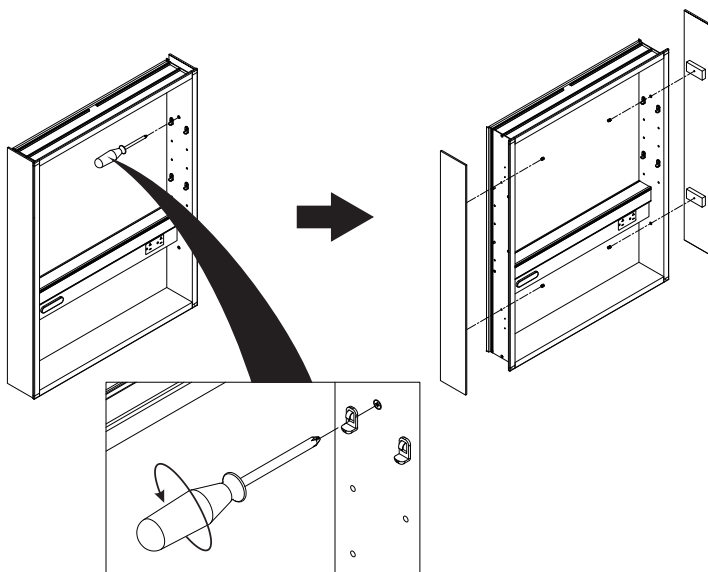



# INSTALLATION

## 1 Intérieur de l'armoire à pharmacie

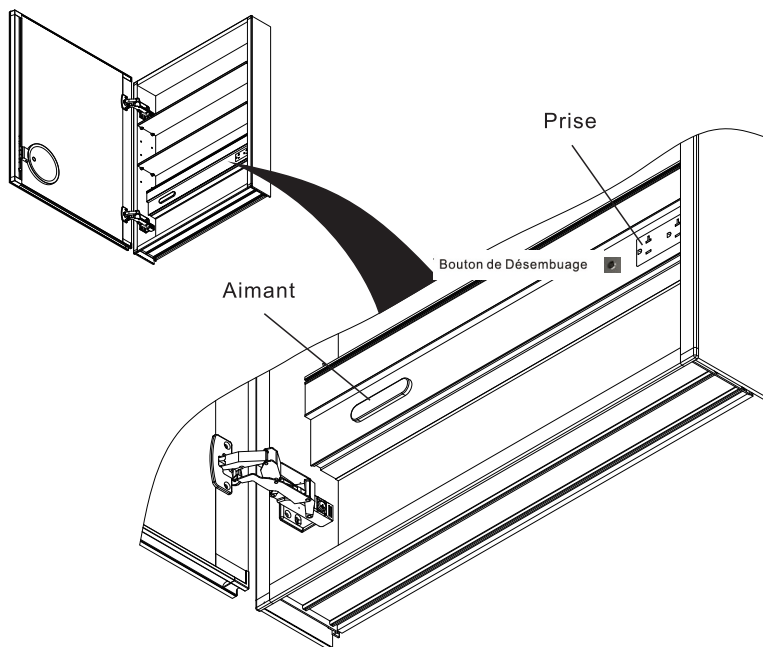

## 2 Retirer les miroirs latéraux de l'armoire à l'aide d'un tournevis.

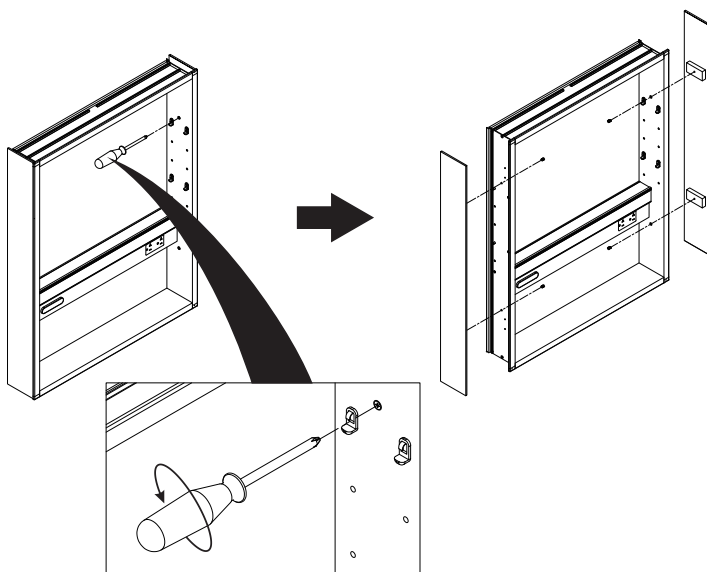

## RECESS-MOUNT INSTALLATION

**1**

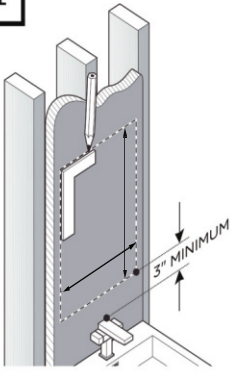

Draw the perimeter of the medicine cabinet on the wall.

**2**

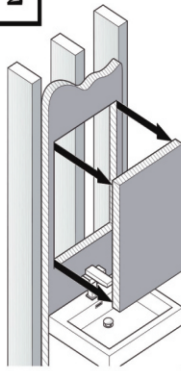

Cut the marked perimeter with appropriate tool.

**3**

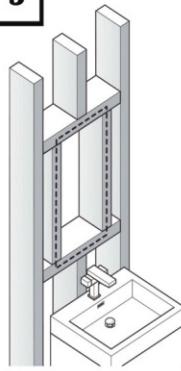

Frame the cutout opening.  
(See Illustration below)

**4**

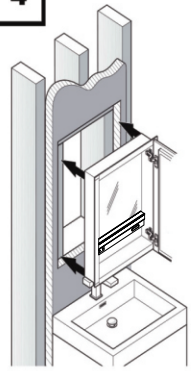

Place and hold the medicine cabinet in the cutout opening.

**5**

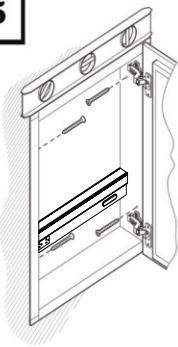

Level, then secure the medicine cabinet with the screws through the mounting holes into the framing studs.

**6**



Choose the position for your shelves, then push and twist the snap-in pins into place.

4 STEPS TO FRAME THE CUTOUT OPENING

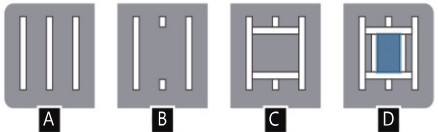

**7**

GLASS SHELF INSTALLATION

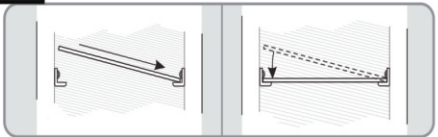

Push a side of the glass shelf into the left or the right pins.

Snap the glass shelf into the opposite side.

**8**

While supporting the door release the lever under the hinge arm. Slide the door off the frame.

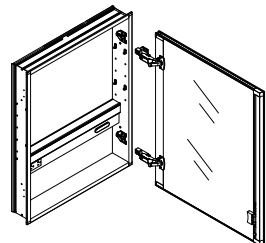
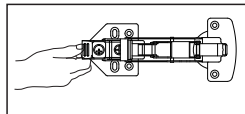
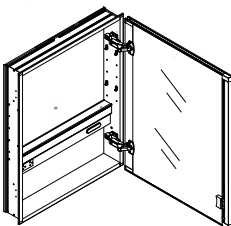

## INSTALACION DE MONTAJE EMPOTRADO

**1**

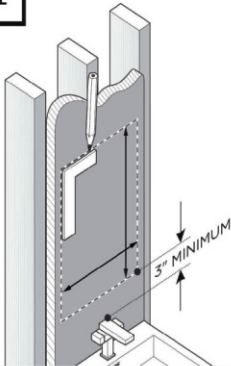

Dibuje el perímetro del gabinete de medicamentos sobre la pared.

**2**

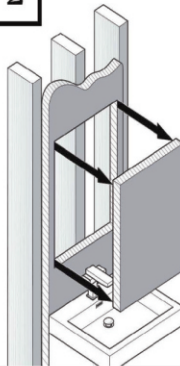

Corte el perímetro marcado con la herramienta correcta.

**3**

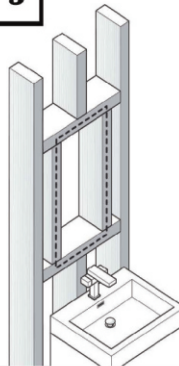

Enmarque la abertura.  
(Vea la ilustración de abajo)

**4**

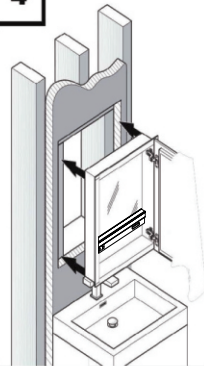

Coloque y sostenga el gabinete de medicamentos en la abertura.

**5**

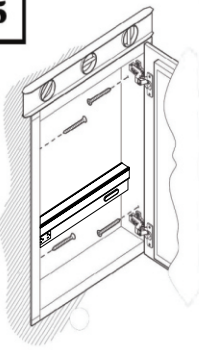

Nivele, después asegure el gabinete con las pijas a través de los orificios sobre el marco.

**6**

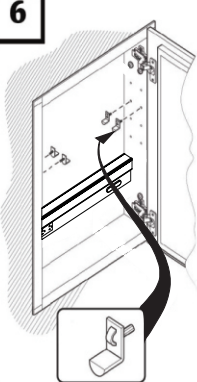

Decida la posición de sus repisas, entonces empuje y gire los pasadores en los lugares correspondientes.

LOS 4 PASOS PARA ENMARCAR LA ABERTURA

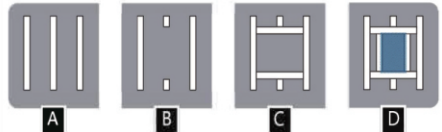

**7**

INSTALACION DEL VIDRIO DE LA REPISA

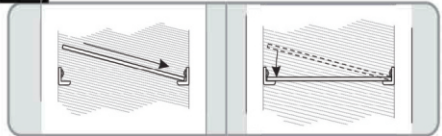

Empuje el vidrio de la repisa hacia un lado sobre los pasadores izquierdo o derecho..

Encaje el vidrio de la repisa en el otro extremo.

**8**

Mientras sujeta la puerta libere el pasador debajo de la bisagra. Deslice la puerta hacia afuera del marco.

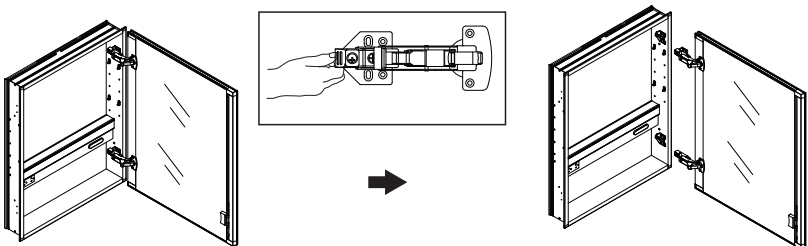

## INSTALLATION ENCASTRÉE

**1**

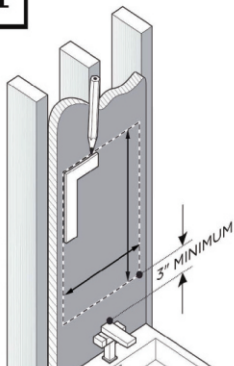

Marquez le périmètre de l'armoire sur le mur.

**2**

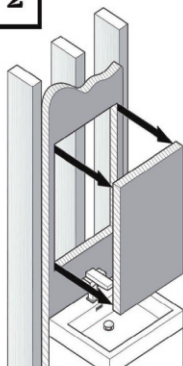

Coupez le périmètre marqué avec l'outil adéquat.

**3**

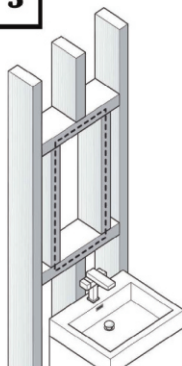

Cadrez l'ouverture.  
(Voyez l'illustration ci-dessous)

**4**

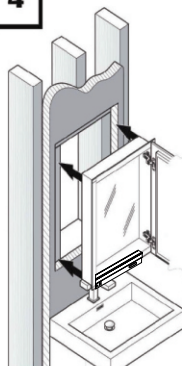

Placez et tenez l'armoire dans l'ouverture.

**5**

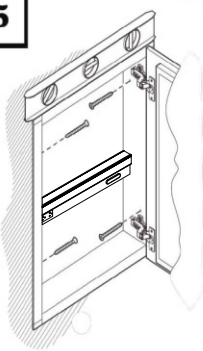

Nivelez, ensuite sécurisez l'armoire avec les vis avec les vis à travers les trous de montage dans les goujons de cadrage

**6**

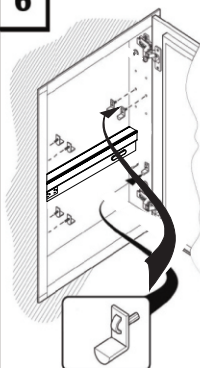

Choisissez la position de vos étagères, puis poussez et tournez les broches à encliqueter en place.

LES 4 ÉTAPES POUR CADRE L'OUVERTURE

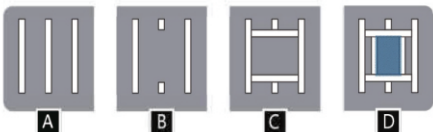

**7**

L'INSTALLATION DE LA TABLETTE À VERRE

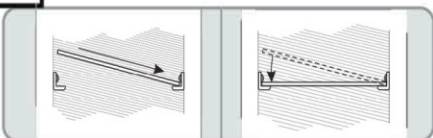

Poussez un côté de l'étagère en verre dans les épingles gauche ou droite.

Enclenchez l'étagère en verre dans le côté opposé.

**8**

Tout en tenant la porte, relâchez le levier dessous du bras de charnière. Glissez la porte du châssis.

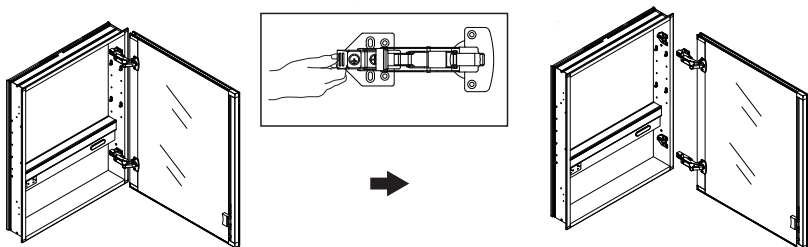

## SURFACE MOUNT

**1**

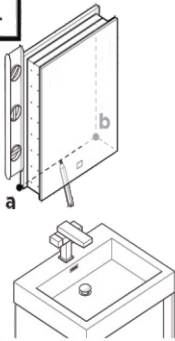

Level and mark the medicine cabinet's location on the wall from point **a** to point **b**.

**2**

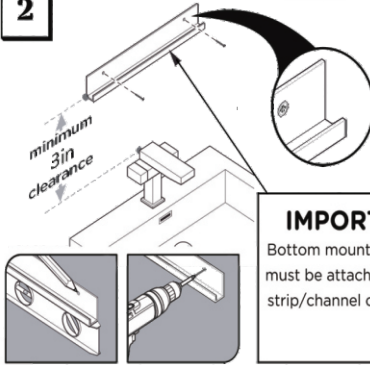

Level and mark. Attach bottom bracket to the wall.

**3**

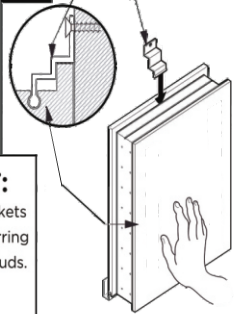

Insert top mounting bracket into the top of the cabinet

**4**

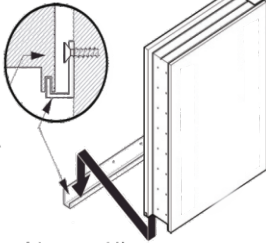

With assistance, rest the medicine cabinet on the bottom mounting bracket and hold it in place.

**5**



You can slide top mounting brackets to the left or right to achieve a desired position.

**6**

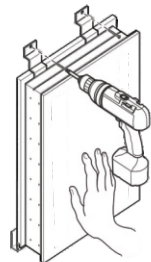

Attach the top mounting brackets to the wall using a drill.

**7**

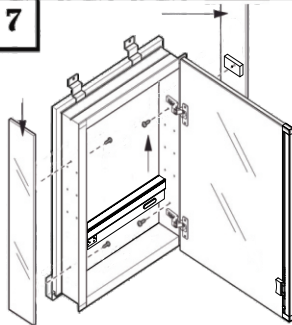

Attach mirrored side panels to the medicine cabinet using a screwdriver and provided screws

**8**

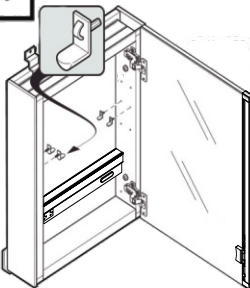

Insert clear snap in shelf clips into holes on the sides of the cabinet.

**9**

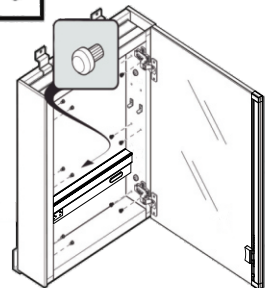

Insert clear plugs into the remaining/unused holes of the cabinet.

## MONTAJE SOBRE SUPERFICIE

1

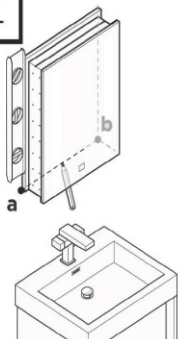

Nivele y marque la ubicación del gabinete sobre la pared desde el punto **a** hasta el punto **b**.

2

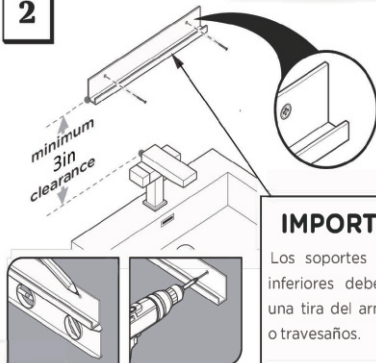

Nivele y marque. Fije el soporte inferior a la pared.

3

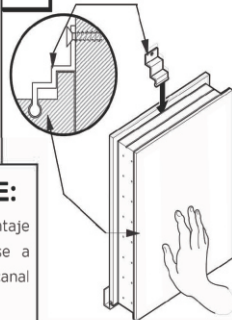

Inserte el soporte superior en la parte superior del gabinete

### IMPORTANTE:

Los soportes de montaje inferiores deben fijarse a una tira del armazón/canal o travesaños.

4

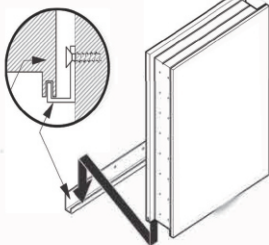

Con ayuda de alguien más, descanse el gabinete sobre el soporte inferior y sostengalo en su lugar.

5



Puede deslizar los soportes superiores hacia la izquierda o derecha para conseguir la posición deseada.

6

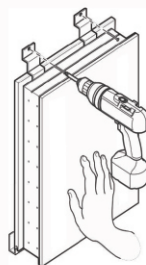

Fije los soportes superiores a la pared utilizando un taladro.

### IMPORTANTE:

Los soportes de montaje superiores deben fijarse a una tira del armazón/canal o travesaños.

7

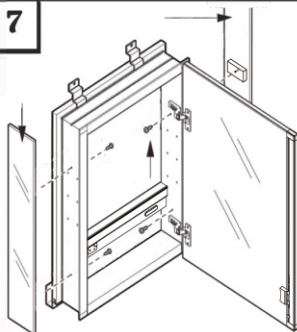

Fije los espejos laterales al gabinete utilizando un desarmador y las pijas incluidas

8

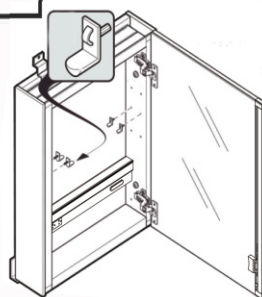

Inserte los broches libres en las grapas de repisa en los costados del gabinete.

9

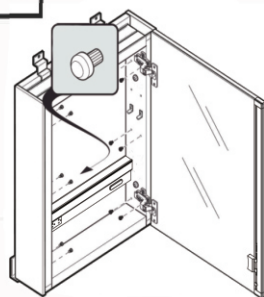

Inserte los tapones de agujero en los huecos restantes o sin usar del gabinete.

## INSTALLATION SUSPENDUE

1

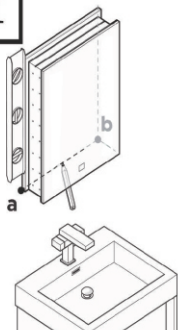

Mettez de niveau et marquez l'emplacement de l'armoire à pharmacie sur le mur depuis le point a jusqu'au point b.

2

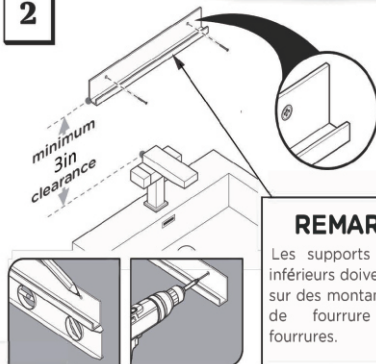

Levez et marquez Fixez le support inférieur au mur.

3

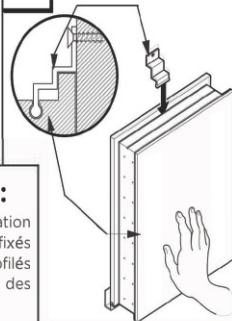

Insérez le support de montage supérieur dans la partie supérieure de l'armoire

4

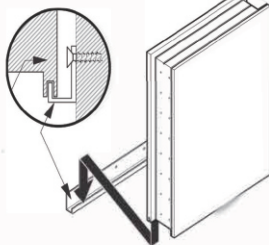

Avec de l'aide, posez l'armoire à pharmacie sur le support de fixation inférieur et maintenez-la en place.

5



Vous pouvez faire glisser les supports de fixation supérieurs vers la gauche ou la droite pour obtenir la position souhaitée.

6

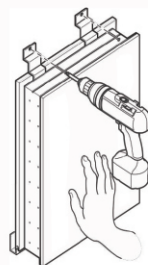

Fixez les supports de fixation supérieurs au mur à l'aide d'une perceuse.

7

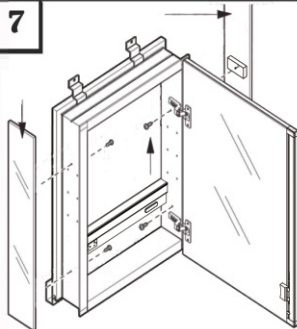

Fixez les panneaux latéraux en miroir sur l'armoire à pharmacie à l'aide d'un tournevis et des vis fournies

8

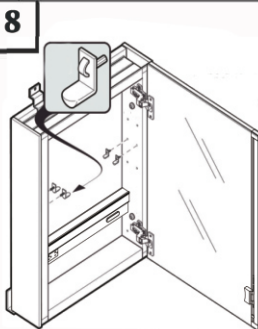

Insérez les supports d'étagère transparents dans les clips de la tablette dans les trous situés sur les côtés du meuble.

9

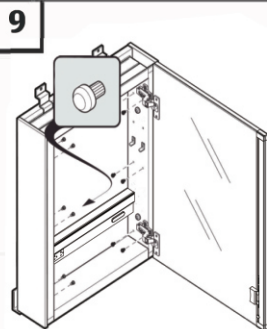

Insérez les bouchons transparents dans les trous restants / inutilisés de l'armoire.

## SURFACE MOUNT

10

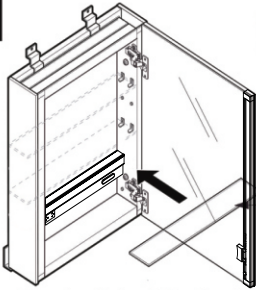

**NOTE:** For more details on the shelf installation please refer to Page 5, Step 7.

C

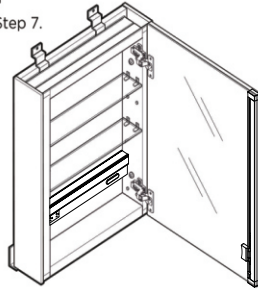

Connect the glass shelves (C) to the cabinet by pushing the side of the shelf in the left or right clip and snapping the shelf down.

## MOUNT BRACKET

1

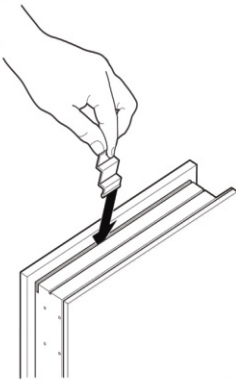

Slide top brackets into channel at the top of the cabinet.

2

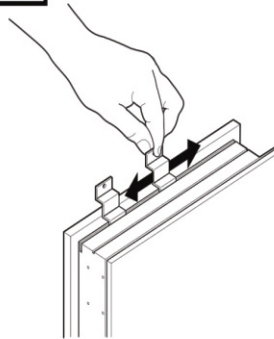

Make sure top brackets are locked in the grooves.

3

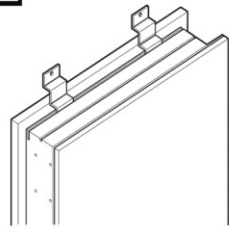

### IMPORTANT:

Top mounting brackets must be attached to furring strip/channel or wall studs.

4

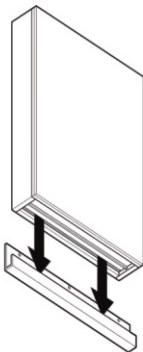

### IMPORTANT:

Make sure cabinet is leveled and fully inserted into the groove of the bottom bracket.

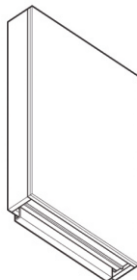

5

Test the fit of the cabinet before Final assembly.

**ELECTRIC WIRING:** Be sure to provide enough wire to make the proper and safe connection to the Field/Power (see Page 5 for electrical connection instructions).



## MONTAJE EN SUPERFICIE

10

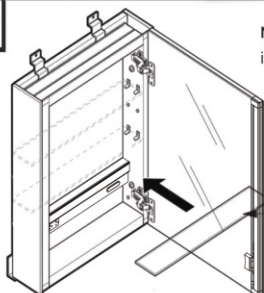

NOTE: For more details on the shelf installation please refer to Page 5, Step 7.

C

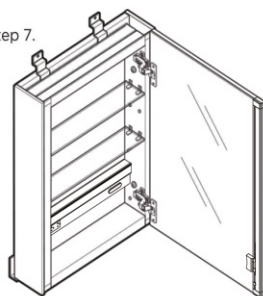

Coloque las repisas de vidrio (C) al gabinete presionando un lado de la repisa sobre la grapa izquierda o derecha y encaje la repisa hacia abajo.

## MONTAJE DE SOPORTE

1

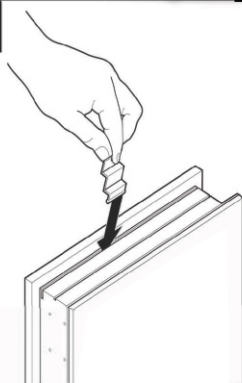

Deslice los soportes superiores dentro del canal superior del gabinete.

2

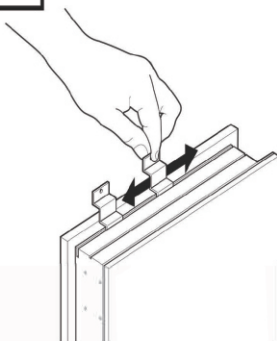

Asegure de que los soportes están bloqueados en las rauras.

3

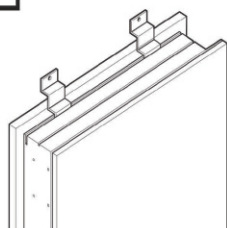

### IMPORTANTE:

Los soportes superiores deben fijarse a una tira del armazón/ canal o travesaño.

4

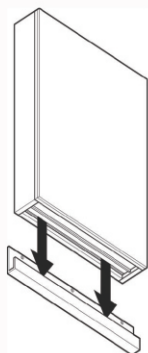

### IMPORTANTE:

Asegúrese de que el gabinete está nivelado y totalmente insertado en la ranura del soporte inferior.

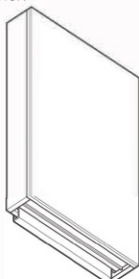

5

Pruebe el ajuste del gabinete antes del armado final.

**CABLEADO ELÉCTRICO:** Asegúrese de proporcionar el cable suficiente para hacer una conexión correcta y segura entre el Campo y la Fuente de Alimentación (ver Página 5 para saber las instrucciones de conexionado eléctrico).

## INSTALLATION SUSPENDUE

10

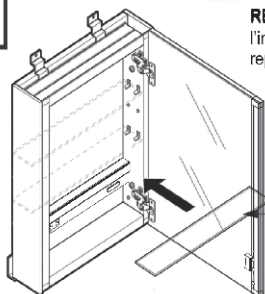

**REMARQUE:** Pour plus de détails sur l'installation des étagères, veuillez vous reporter à la page 5, étape 7.

C

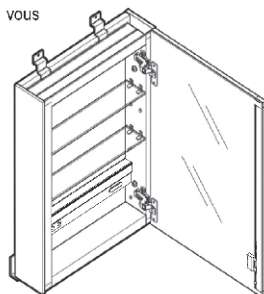

Fixez les étagères en verre (C) au meuble en appuyant un côté de l'étagère sur l'agrafe gauche ou droite et abaissez-la.

## MOUNT BRACKET

1

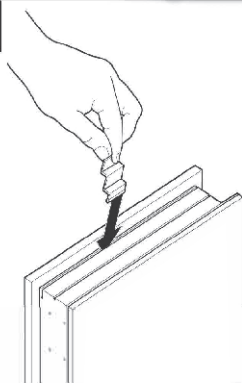

Faites glisser les supports supérieurs dans le canal supérieur de l'armoire.

2

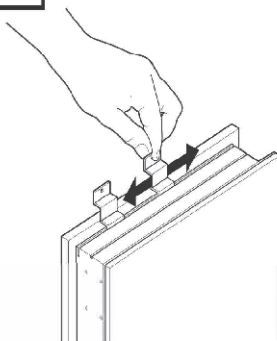

Assurez-vous que les supports sont verrouillés dans les rails.

3

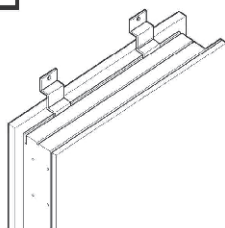

### IMPORTANT:

Les supports supérieurs doivent être fixés à une bande du cadre / canal ou barre transversale.

4

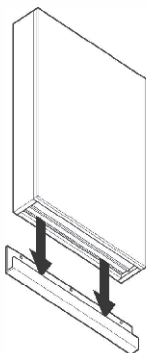

### IMPORTANT:

Assurez-vous que le boîtier est de niveau et complètement inséré dans la rainure du support inférieur.

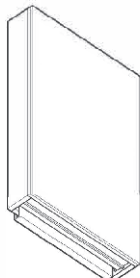

5

Testez l'ajustement de l'armoire avant l'assemblage final.

**CÂBLAGE ÉLECTRIQUE:** Assurez-vous de fournir suffisamment de fil pour établir une connexion correcte et sûre au champ / à l'alimentation (voir les instructions de connexion électrique à la page 5).

## LAST STEPS

- 1** Slide the doors into place by pinching the end of the hinge.

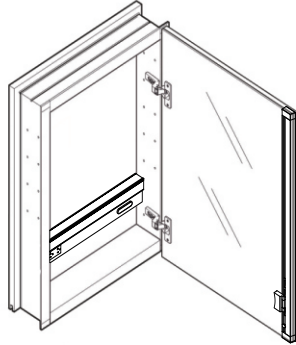
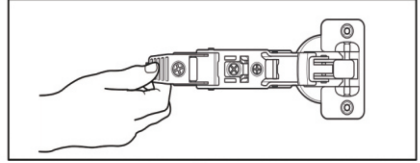
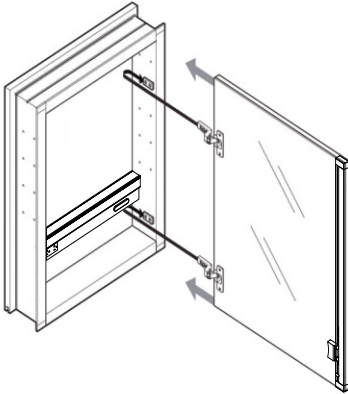

- 2**  
**2 a.** Insert clear snap in shelf clips (F) into holes on the sides of the cabinet (A).

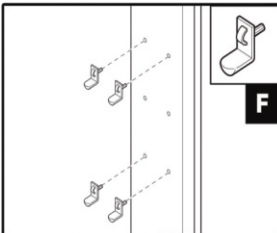

- 2 b.** Push the side of the shelf (C) in the left or right clip and snap the shelf (C) down.

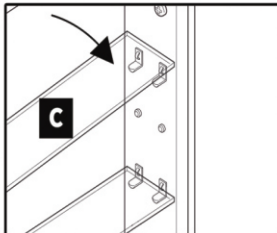

- 2 c.** Insert clear plugs (H) into the remaining or unused holes.

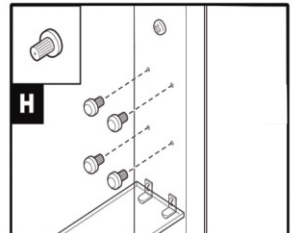

## ULTIMOS PASOS

**1**

Deslice las puertas en su lugar empujando el final de la bisagra.

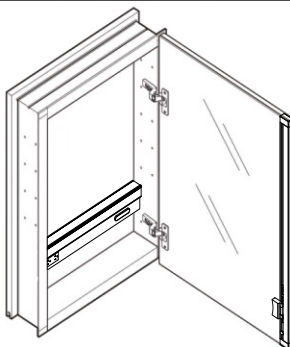
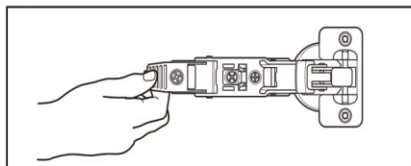
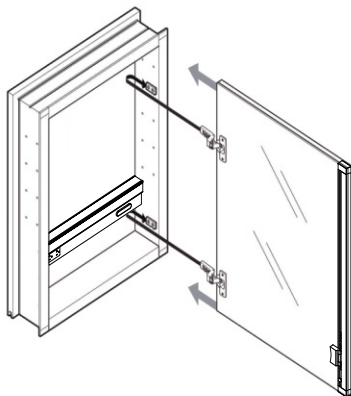

**2**

**2 a.** Inserte las grapas de soporte de las repisas (F) en los orificios de los costados del gabinete (A).

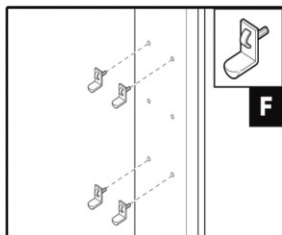

**2 b.** Empuje un lado de la repisa (C) en la grapa izquierda o derecha y encaje la repisa (C) hacia abajo.

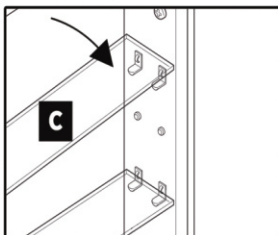

**2 c.** Inserte los tapones (H) en los huecos faltantes o sin usarse.

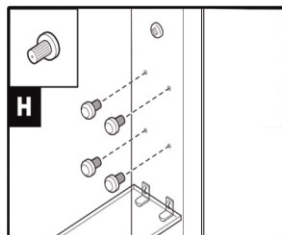

## DERNIÈRES ÉTAPES

- 1** Faites glisser les portes en place en pinçant l'extrémité de la charnière.

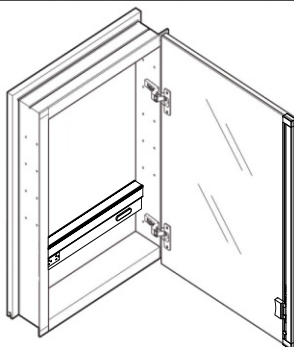
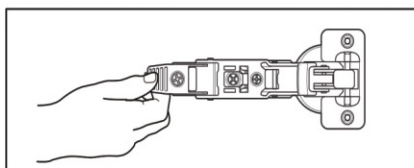
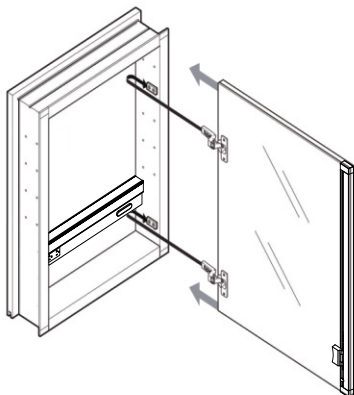

- 2** **2 a.** Insérez les clips transparents (F) dans les trous situés sur les côtés du meuble (A).

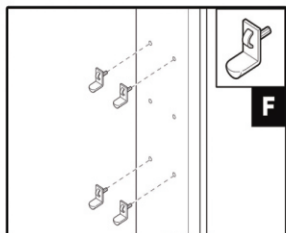

- 2 b.** Poussez le côté de la tablette (C) idans le clip gauche ou droit et abaissez la tablette (C).

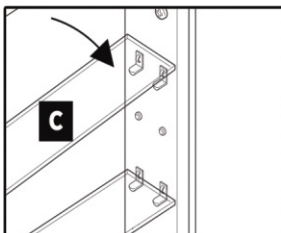

- 2 c.** Insérez les bouchons transparents (H) dans les trous restants ou non utilisés.

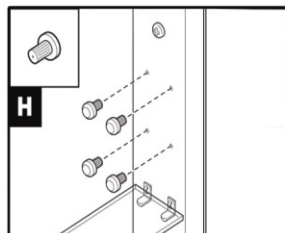

## MAKEUP MIRROR

1

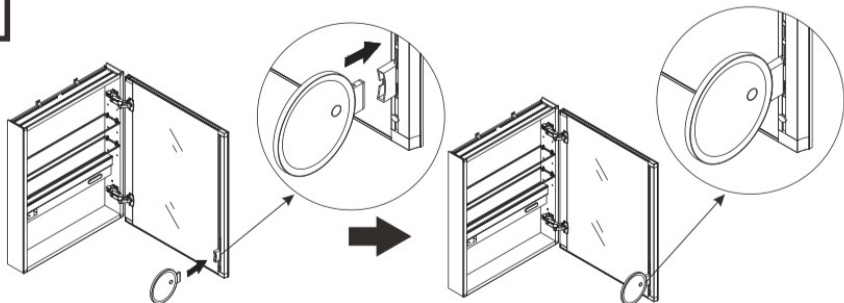

**NOTE:** Slide the makeup mirror into the place

2



Tap to turn ON/ OFF  
Long press for dimming

3

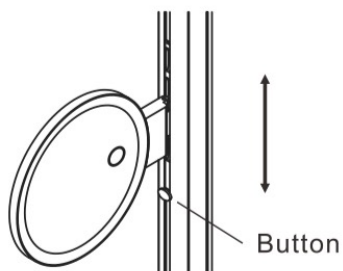

Press and hold the button to adjust  
the height of the makeup mirror

4

Built-in spring, easy to take out the makeup mirror

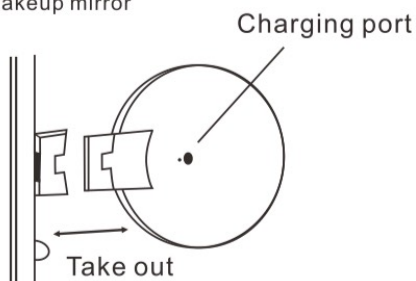
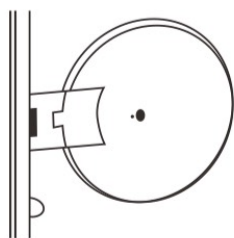

Charge it using the included USB cable  
If the indicator is red, the battery is charging.  
When the battery is fully charged, the indicator becomes green

## ESPEJO DE MAQUILLAJE

1

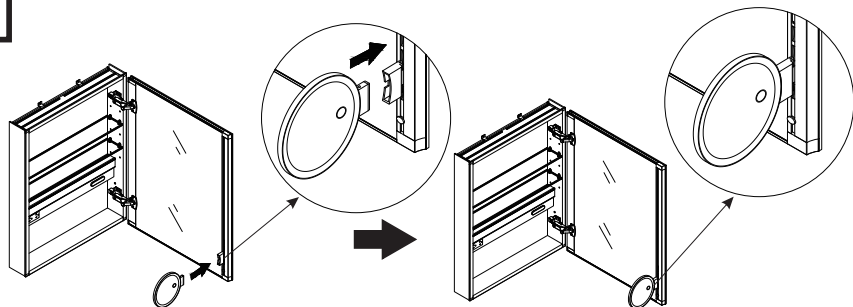

**NOTA:** deslice el espejo de maquillaje en el lugar

2

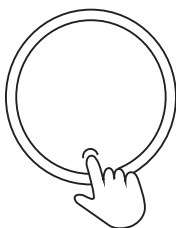

Appuyez sur le bouton pour allumer/  
éteindre la lampe de maquillage  
Pulsar largo el botón de interruptor  
para ajustar el brillo

3

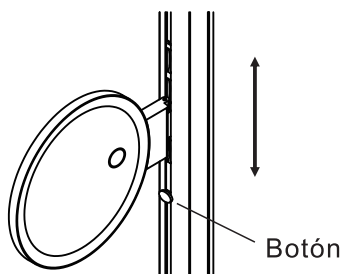

Mantenga pulsado el botón para ajustar  
la altura del espejo de maquillaje

4

Primavera incorporada, fácil sacar el espejo del maquillaje

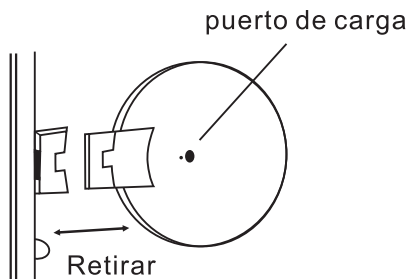
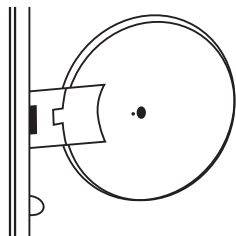

Cargarlo usando el cable USB incluido  
Si el indicador es rojo, la batería se está cargando.  
Cuando la batería está completamente cargada, el indicador se vuelve verde

## MIROIR DE MAQUILLAGE

1

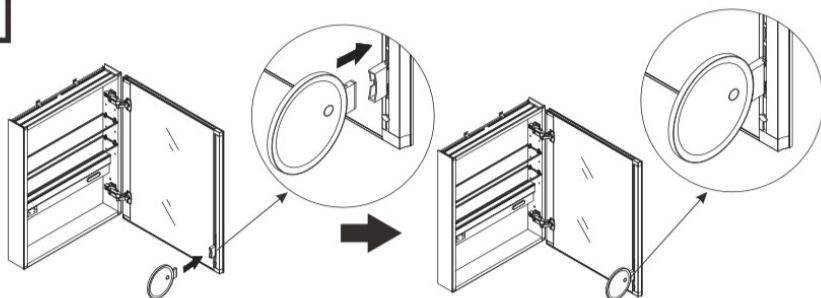

**REMARQUE:** Glisser le miroir de maquillage dans l'endroit

2

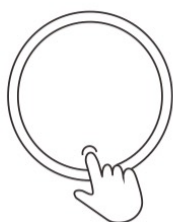

Appuyez sur le bouton pour allumer/  
éteindre la lampe de maquillage  
Appuyer longuement sur le bouton du  
commutateur pour régler la luminosité

3

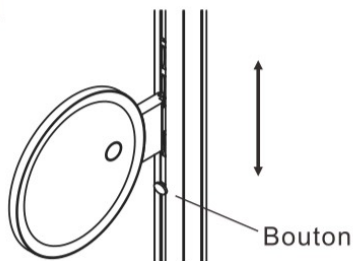

Maintenez le bouton enfoncé pour régler  
la hauteur du miroir de maquillage

4

Printemps intégré, facile à enlever le miroir de maquillage

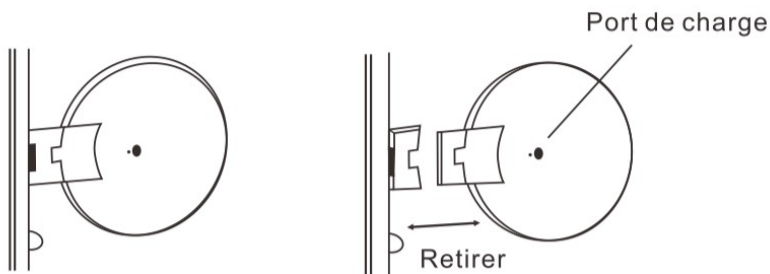

Rechargez-le avec le câble USB inclus  
Si l'indicateur est rouge, la batterie se charge.  
Lorsque la batterie est complètement chargée, l'indicateur devient vert





# AQUADOM Mirror Installation Guide

## IMPORTANT SAFETY INSTRUCTIONS

*When using an electrical furnishing, basic precautions should always be followed, including the following:*



### **DANGER**

**READ AND FOLLOW ALL INSTRUCTIONS BEFORE USING THIS MIRROR.**



### **WARNING**

Risk of electric shock. Connect this furnishing to a properly grounded circuit only. See Grounding instructions.



### **WARNING**

To reduce the risk of burns, fire, electric shock or injury to persons. Use this furnishing only for its intended use as described in these instructions. Do not use attachments not recommended by the manufacturer. Never drop or insert any object into any opening. Do not use outdoors.

## **GROUNDING INSTRUCTIONS:**

This product must be connected to a grounded metal, permanent wiring system, or an equipment-grounding conductor must be run with the circuit conductors and connected to the equipment-grounding terminal or lead on the product.



### **WARNING**

An Electrical option cabinet must be wired to a 20 Amp GFI (Ground Fault Interrupter) protected circuit when used in bathrooms and all other locations required by the National Electric Code.

PLEASE SAVE THESE INSTRUCTIONS FOR FUTURE REFERENCE



# Guía de Instalación de Espejo AQUADOM

## INSTRUCCIONES IMPORTANTES DE SEGURIDAD

*Cuando de está usando equipo eléctrico, precauciones básicas deben seguirse, incluyendo las siguientes:*



### PELIGRO

**LEA Y SIGUA TODAS LAS INSTRUCCIONES ANTES DE USAR ESTE ESPEJO.**



### ADVERTENCIA

Riesgo de choque eléctrico. Conecte este equipo a un circuito apropiado de tierra física. Vea las instrucciones de Aterrizado.



### ADVERTENCIA

Para reducir los riesgos de quemadura, fuego, choque eléctrico o lastimar a alguien. Utilice este equipo únicamente para el uso previsto como se describe en estas instrucciones. No utilice accesorios no recomendados por el fabricante. Nunca deje caer o introduzca algún objeto dentro de cualquier abertura. No se use en el exterior.

## INSTRUCCIONES DE ATERRIZAJE:

Este producto debe conectarse a una tierra metálica, a un de cableado permanente, o a un conductor de aterrizaje de equipos que debe correr con el circuito de conductores y conectados a una terminal general de aterrizaje de equipos.



### ADVERTENCIA

Una opción eléctrica para el gabinete deba estar cableado a un circuito protegido con un Interruptor de Falla a Tierra (GFI) de 20 Amp cuando se usa en baños y en todas aquellas ubicaciones que requieran la aplicación del Código Eléctrico Nacional (NEC).

POR FAVOR GUARDE ESTAS INSTRUCCIONES PARA REFERENCIA POSTERIOR

## CONSIGNES DE SÉCURITÉ IMPORTANTES

*Lors de l'utilisation d'un équipement électrique, des précautions élémentaires doivent toujours être suivies, notamment les suivantes:*



### **DANGER**

**LISEZ ET SUIVEZ TOUTES LES INSTRUCTIONS AVANT D'UTILISER CE MIROIR.**



### **ATTENTION**

Risque de choc électrique. Connecter cette fournir à un circuit correctement mis à la terre seulement. Voir les instructions de mise à la terre.



### **ATTENTION**

Pour réduire les risques de brûlure, d'incendie, de choc électrique ou de blessure. Utilisez cet appareil uniquement pour l'usage auquel il est destiné, comme décrit dans ces instructions. N'utilisez pas d'accessoires non recommandés par le fabricant. Ne jamais laisser tomber ou insérer un objet dans une ouverture. Ne pas utiliser à l'extérieur.

## **INSTRUCTIONS DE MISE À LA TERRE:**

Ce produit doit être connecté à un système de câblage permanent en métal mis à la terre ou un conducteur de mise à la terre de l'équipement doit être branché avec les conducteurs du circuit et connecté à la borne de mise à la terre de l'équipement ou au fil situé sur le produit.



### **ATTENTION**

Une option électrique de l'armoire doit être câblée sur un circuit protégé par un interrupteur de fuite à la terre (GFI) de 20 Amp lorsqu'elle est utilisée dans les salles de bains et tous les autres endroits requis par le code national de l'électricité.

VEUILLEZ CONSERVER CES INSTRUCTIONS POUR FUTURE RÉFÉRENCE



# AQUADOM Installation Guide

## WARRANTY

AQUADOM warrants to the original purchaser that it will, at its election, repair, replace, or make appropriate adjustment to products made by this company shown to have significant defects in material or workmanship which are reported to AQUADOM in writing within one (1) year from the date of delivery. AQUADOM is not responsible for installation costs.

The warranty is void in the event the product is damaged in transit, or if damage or failure is caused by abuse, misuse, abnormal usage, faulty installation, damage in an accident, improper maintenance, or any repairs other than those authorized by AQUADOM.

At the expiration of the one-year warranty period, AQUADOM shall be under no further obligation under any warranty, expressed or implied, including the implied warranty of merchantability.

AQUADOM shall not be liable for any consequential damages arising out of or in connection with the use or performance of its products. Some states do not allow limitations on how long an implied warranty lasts or do not allow the exclusion or limitation of incidental or consequential damages, so the above limitation or exclusion may not apply to you.

Any liability against AQUADOM under any implied warranty, including the warranty of merchantability, is expressly limited to the terms of this warranty. Permission to return any merchandise under this warranty must be authorized by AQUADOM and returned prepaid by the purchaser.



# Guía de Instalación AQUADOM

## GARANTÍA

**AQUADOM garantiza al primer comprador que, a su elección, reparará, reemplazará o hará los ajustes apropiados a los productos fabricados por esta compañía que demuestren tener defectos significativos en material o mano de obra los cuales hayan sido reportados a AQUADOM por escrito dentro del primer (1) año desde la fecha de entrega.**

**AQUADOM no se hace responsable por costos de instalación.**

**La garantía no es válida en el caso de que el producto haya sido dañado durante el tránsito o si el daño o falla es causado por abuso, mal uso, uso anormal, instalación errónea, daño por accidente, mantenimiento inadecuado, o cualquier otra reparación hecha por otros diferentes a los autorizados por AQUADOM.**

**Al término del período de garantía de un año, AQUADOM no tendrá la obligación de proporcionar alguna otra garantía, expresa o implícita, incluyendo la garantía implícita de comerciabilidad.**

**AQUADOM no se responsabilizará por ningún daño resultante que surjan de o se relacione con el uso o desempeño de sus productos. Algunos estados no permiten limitaciones en el tiempo de duración de una garantía implícita o no permiten la exclusión o limitación de accidentes o daños resultantes, por lo que la limitación o exclusión anterior podría no aplicar para usted.**

**Cualquier responsabilidad en contra de AQUADOM bajo cualquier garantía implícita, incluyendo la garantía de comerciabilidad, está expresamente limitada bajo los términos de la presente garantía. La autorización de devolución de cualquier mercancía bajo esta garantía debe ser autorizada por AQUADOM y el envío de devolución prepagado por el comprador.**

## GARANTIE

AQUADOM garantit à l'acheteur initial qu'il réparera, remplacera ou apportera, le cas échéant, les ajustements appropriés aux produits fabriqués par cette société et présentant des défauts de fabrication importants qui seront signalés à AQUADOM par écrit dans un délai d'un (1) an, à partir de la date de livraison. AQUADOM n'est pas responsable des coûts d'installation.

La garantie est annulée si le produit est endommagé pendant le transport, ou si le dommage ou la défaillance est causé par un usage abusif, mauvais usage, une utilisation anormale, une installation défectueuse, un accident, un entretien inadéquat ou des réparations par autres que celles autorisées par AQUADOM.

À l'expiration de la période de garantie d'un an, AQUADOM n'aura plus aucune obligation, sous aucune garantie, explicite ou implicite, y compris la garantie implicite de qualité marchande.

AQUADOM ne peut être tenu responsable des dommages indirects résultant de l'utilisation ou de la performance de ses produits ou liés à l'utilisation de ces produits. Certains états n'autorisent pas de limitation de la durée d'une garantie implicite ou n'autorisent pas l'exclusion ou la limitation des dommages accessoires ou indirects. Par conséquent, la limitation ou l'exclusion ci-dessus peut ne pas s'appliquer à vous.

Toute responsabilité vis-à-vis d'AQUADOM en vertu d'une garantie implicite, y compris la garantie de qualité marchande, est expressément limitée aux conditions de cette garantie. La permission de retourner toute marchandise dans le cadre de cette garantie doit être autorisée par AQUADOM et renvoyée prépayée par l'acheteur.



